

# UM10694

## SSL2109ADB1107 - 230 V/7 W GU10 high PF isolated LED driver demo board

Rev. 1 — 9 April 2013

User manual

### Document information

Info	Content
<b>Keywords</b>	SSL2109ADB1107, flyback converter, high power factor, GU10
<b>Abstract</b>	This document describes the operation of a 230 V/7 W non-dimmable LED driver demo board featuring SSL2109A and using an isolated flyback topology. The SSL2109ADB1107 demo board is designed for GU10 form factors used in Solid State Lighting (SSL) applications.

**Revision history**

<b>Rev</b>	<b>Date</b>	<b>Description</b>
v. 1	20130409	first issue

**WARNING****Lethal voltage and fire ignition hazard**

The non-insulated high voltages that are present when operating this product, constitute a risk of electric shock, personal injury, death and/or ignition of fire.

This product is intended for evaluation purposes only. It shall be operated in a designated test area by personnel qualified according to local requirements and labor laws to work with non-insulated mains voltages and high-voltage circuits. This product shall never be operated unattended.

## 1. Introduction

This user manual describes the operation of the SSL2109ADB1107 demo board featuring the SSL LED driver SSL2109A in a 230 V/7 W isolated flyback converter application.

The SSL2109ADB1107 demo board is designed for driving a 3-LED string load.

The PCB dimensions are compatible with GU10 form factors used in SSL applications.

The demo board provides a simple and effective solution having a power factor greater than 0.9 and efficiency up to 85 % for SSL applications.

### 1.1 Features of the application

- GU10 form factor compatibility
- Open LED and short circuit LED string protection
- OverCurrent protection (OCP) and OverTemperature protection (OTP)
- Power factor (PF) greater than 0.9 and THD < 20 %
- Efficiency up to 85 %
- Compliant with IEC61000-3-2 harmonics standard

The assembled top and bottom board views are shown in [Fig 1](#) with the board dimensions in [Fig 3](#). The board dimensions allow enough headroom with GU10 lamps.



a. Top view

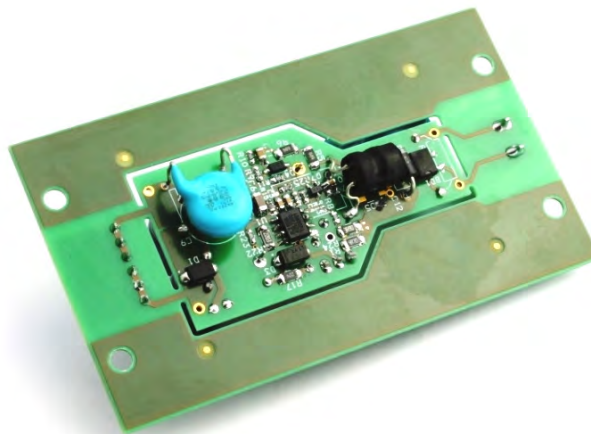

b. Bottom view

Fig 1. SSL2109ADB1107 230 V/7 W GU10 demo board

## 2. Safety

The board is connected to mains voltage. Avoid touching the demo board while it is connected to the mains voltage. An isolated housing is obligatory when used in uncontrolled, non-laboratory environments. Galvanic isolation of the mains phase using a variable transformer is always recommended.

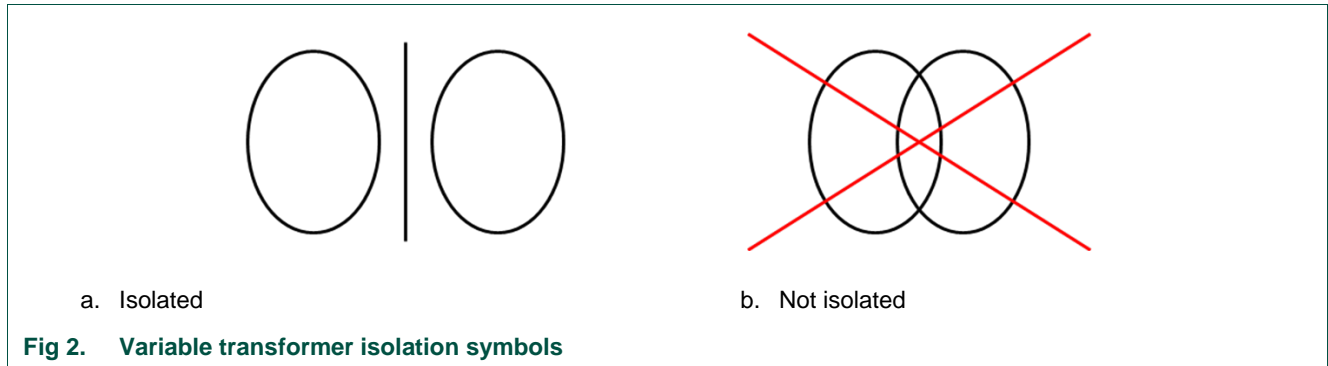

### 3. Specifications

**Table 1. Specifications of the SSL2109ADB1107**

Symbol	Parameter	Value
$V_{mains}$	AC mains supply voltage	230 V; $\pm 10\%$
$P_{in}$	input power	6.9 W at nominal $V_{mains} = 230$ V
$P_{out}$	output power	5.9 W
$V_{LED}$	output voltage (LED voltage)	8 V to 14 V with nominal $V_{LED} = 10.8$ V
$I_{LED}$	output current (LED current)	550 mA
$I_{ripple}$	output ripple current	215 mA (p-p)
$\Delta I_{LED} / \Delta V_{mains}$	line regulation	0.6 mA/V ( $\pm 2.5\%$ ; $I_{LED}$ at $\pm 10\%$ $V_{mains}$ variation)
$\Delta I_{LED} / \Delta V_{LED}$	load regulation	4 mA/V ( $\pm 1\%$ ; $I_{LED}$ at $\pm 10\%$ $V_{LED}$ variation)
$\eta$	efficiency	85 %
PF	power factor	0.92
THD	total harmonic distortion	19 %
$f_{sw}$	switching frequency	70 kHz

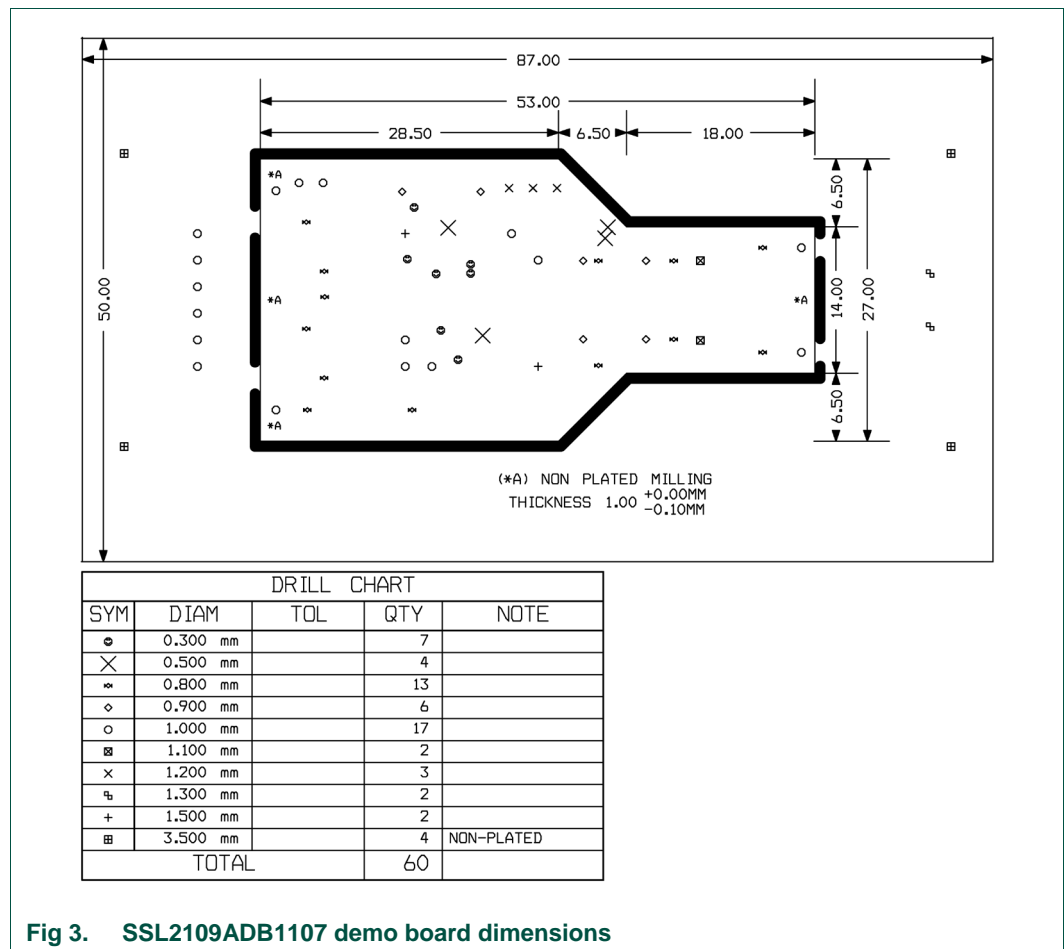

**Fig 3. SSL2109ADB1107 demo board dimensions**

## 4. Functional description

### 4.1 Input filtering

A differential mode  $\pi$  filter is implemented to reduce differential mode noise originating from the High-frequency (HF) switching currents/voltages in the primary of the converter from returning to the mains. This noise must be kept to a minimum by:

- Small primary current loop (C2 to pin 5 of T1, pin 3 of T1 to drain of external MOSFET Q5, ground return from sense resistors R1, R24, R26 to C2 ground)
- Snubber components D3, R17, C8 closely parallel to pins 5 and 3 of T1
- Track length from pin 3 of T1 to drain of external MOSFET to be small in order to reduce capacitance to surroundings

For this 7 W application, C2 must be chosen sufficiently large to act as a buffer for the HF current flowing in the primary but also small enough to maintain a high PF where a value of 100 nF for C2 is a good compromise.

### 4.2 PF adjustment

The divider network consisting of R5, R6, R7, R9, R10, D4, C10 and C11 modulates the base of Q7 according to the rectified mains. Consequently, a modulating current set by R11 flows through R8 and the sense current through R1, R24 and R26 is also modulated. Depending on the divider resistor values, the HF current through the primary has a current with a rectified mains modulation resulting in a high PF.

The PF can be increased/decreased by decreasing/increasing R5 and R6 and a compromise can be reached between PF and line regulation.

### 4.3 RCD clamp

Leakage inductance of the transformer is in series with primary inductance and the drain of MOSFET Q5. This leakage inductance together with the parasitic capacitance across the drain source of Q5 causes HF ringing when Q5 switches off. If the leakage is not minimized the voltage at the drain reaches high voltages levels which can damage Q5 if voltage levels exceed the maximum allowable level.

An RCD clamp (R17, C8 and D3) prevents the voltage on the drain of Q5 exceeding the maximum drain voltage when Q5 switches off.

### 4.4 Supply voltage

The supply voltage of the SSL2109A is achieved using an auxiliary winding. As further advantages, the auxiliary winding provides, via a resistor R25 on its underwinding, both a simple solution for improved load regulation using R12 and open-circuit protection (OCP) via the NTC pin using R13.

#### 4.4.1 Open-circuit protection

If no LED string is connected to the converter output, the voltage can quickly exceed the maximum rating of the output capacitors C3 and C13.

The underwinding of the auxiliary is connected to resistor R25 to prevent this. The voltage across R25 decreases as the output voltage increases. Consequently, the voltage at the NTC pin decreases once the current through R13 exceeds the internal current of the NTC pin. When the NTC voltage drops below 0.35 V then the SSL2109A switches off.

An external 18 V Zener diode is included at the VCC pin to prevent that the voltage exceeds 20 V at the VCC pin for this no LED string situation.

#### 4.4.2 Short circuit

When the LED terminals are shorted, the SSL2109A defaults to its maximum demagnetization time of 36  $\mu$ s. This prevents that the inductor current ramps up to an excessively large value while the input power is limited and the SSL2109A enters OPS protection (latched) mode.

**Remark:**

Do not try to short-circuit the LED output while the circuit is powered or without discharging C3. The short-circuit protection is intended for zero-hour short circuit protection (so a short circuit during first assembly before power is applied).



## 5. Demo board connections

The SSL2109ADB1107 demo board is supplied with a 230 V, 50 Hz mains supply where the board connection is shown in [Fig 4](#).

**Table 2. Input and output connections**

Connector	Function	Remark
L	AC MainsL	line wire solder connection on small board
N	AC MainsN	neutral wire solder connection on small board
+	LED anode	positive LED wire solder connection on small board
-	LED cathode	negative LED wire solder connection on small board
X5	AC mains input	AC mains in terminal block
X6	LED load output	LED connector 6-way female for Silergy LED load

### Remarks:

Make all connections with the input mains supply switched off.

Use a protective shield over application and never touch the board when measuring or testing.

### Connections and testing:

- Connect 3-LED string load to the SSL2109ADB1107 together with power meters at both inputs and outputs.
- Connect  $V_{\text{mains}}$  (230 V (AC)/50 Hz) using an isolating transformer (initially set to 0 V) to the input connection points of the flyback converter. Alternatively, use an AC power supply with limited output current capability (for example 200 mA).
- Increase  $V_{\text{mains}}$  to 230 V (AC) and measure the different parameters as shown in [Table 3](#).

**Table 3. Input/output parameters SSL2109ADB1107**

$V_{\text{mains}}$ (V)	$I_{\text{in}}$ (mA)	PF	$P_{\text{in}}$ (W)	$V_{\text{LED}}$ (V)	$I_{\text{LED}}$ (mA)	$P_{\text{out}}$ (W)	$\eta$
230	33	0.92	6.9	10.8	550	5.9	0.85



## 6. Performance data SSL2109ADB1107

### 6.1 Efficiency

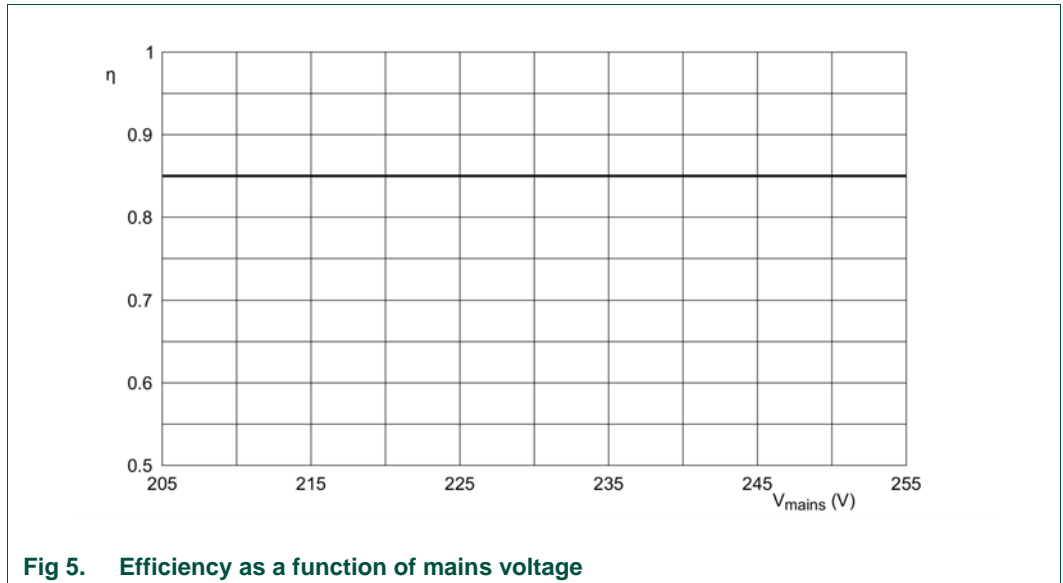

### 6.2 Power factor

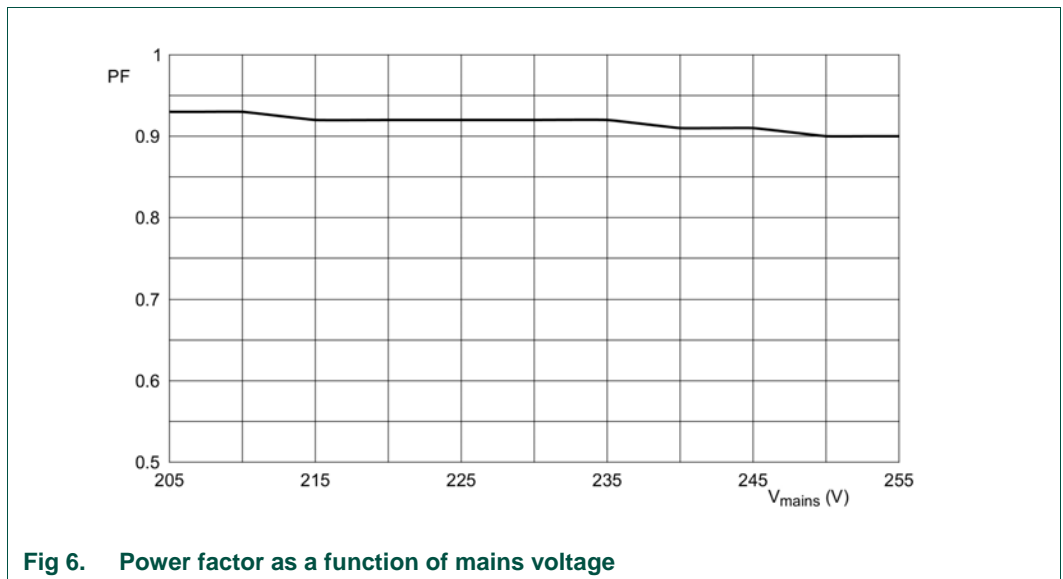

**6.3 Line regulation**

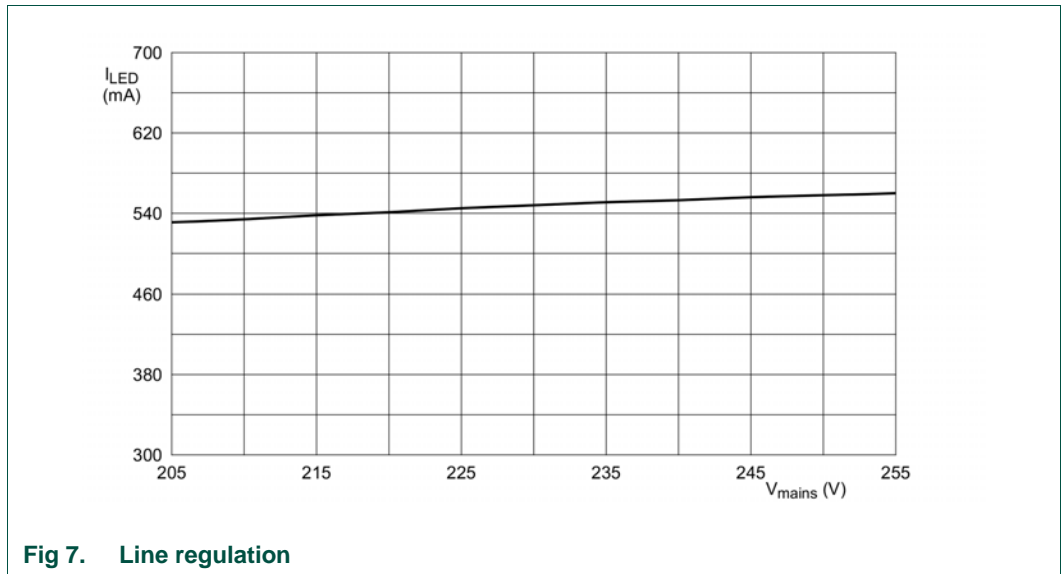

**6.4 Load regulation**

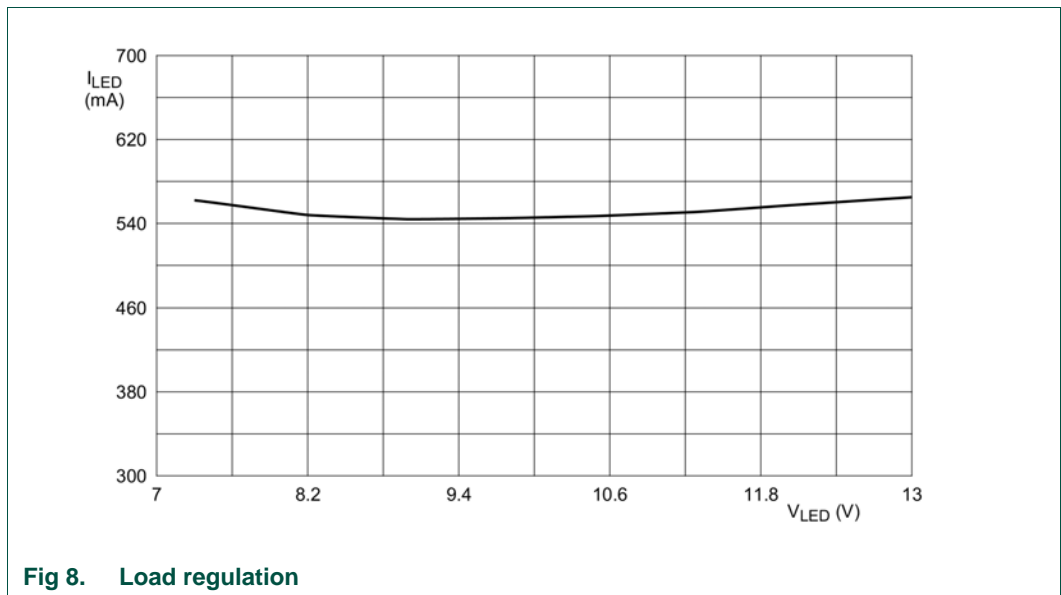

6.5 ElectroMagnetic Interference (EMI)

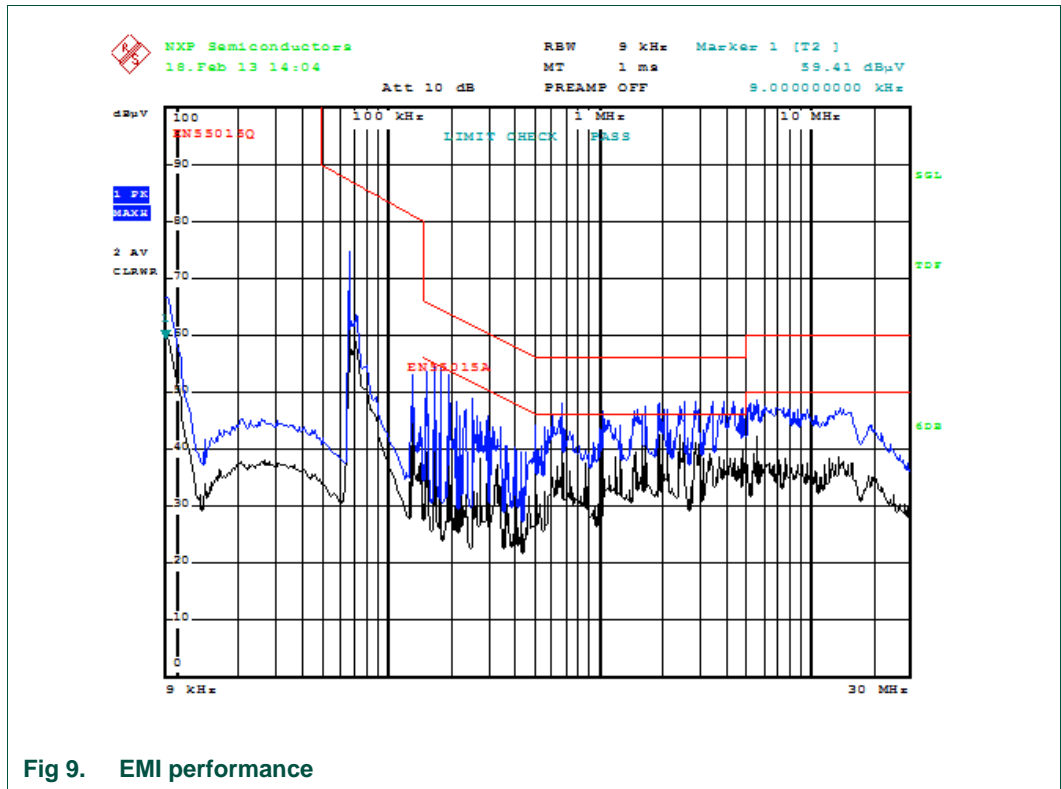

## 7. Schematic diagram

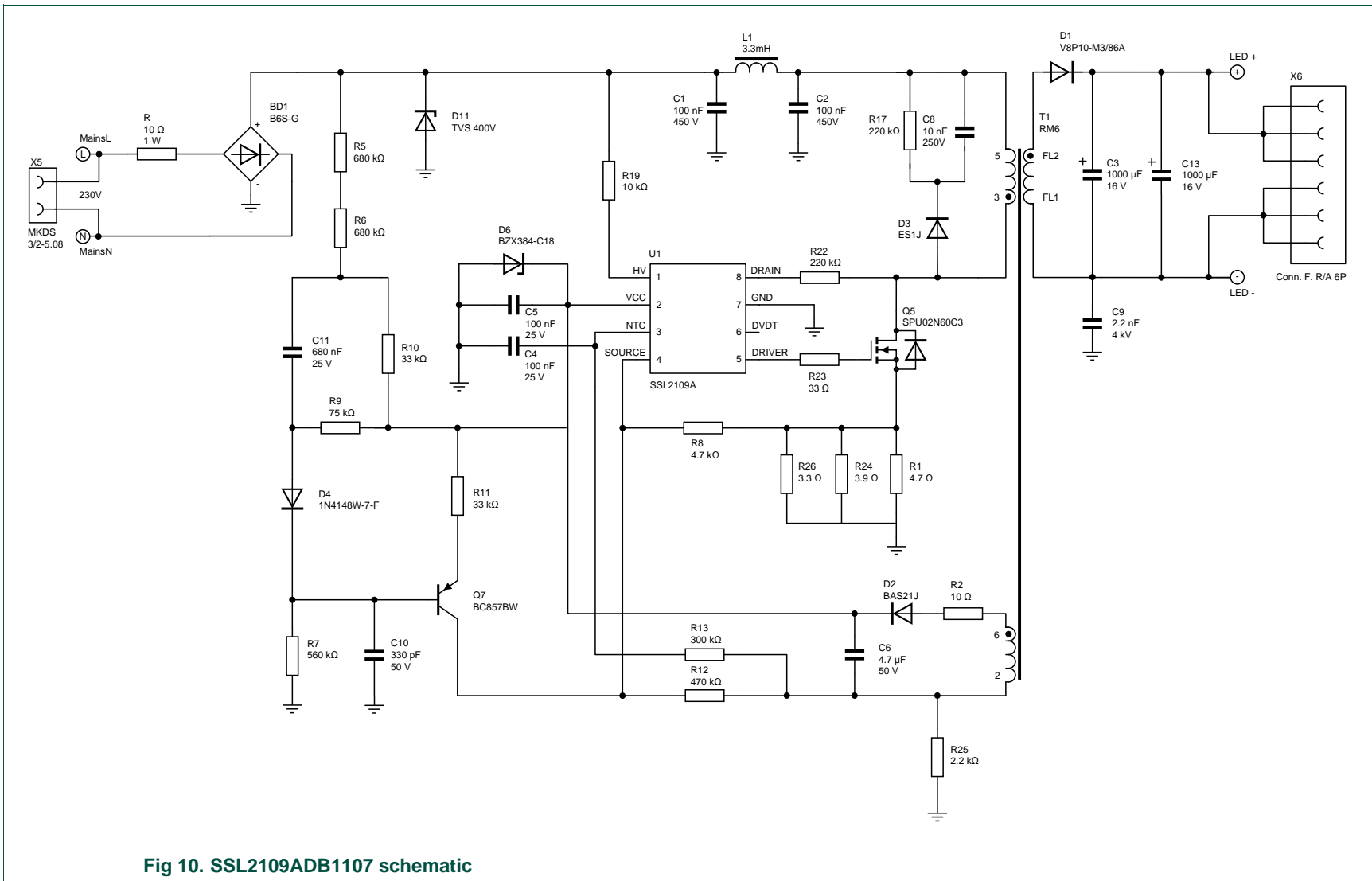
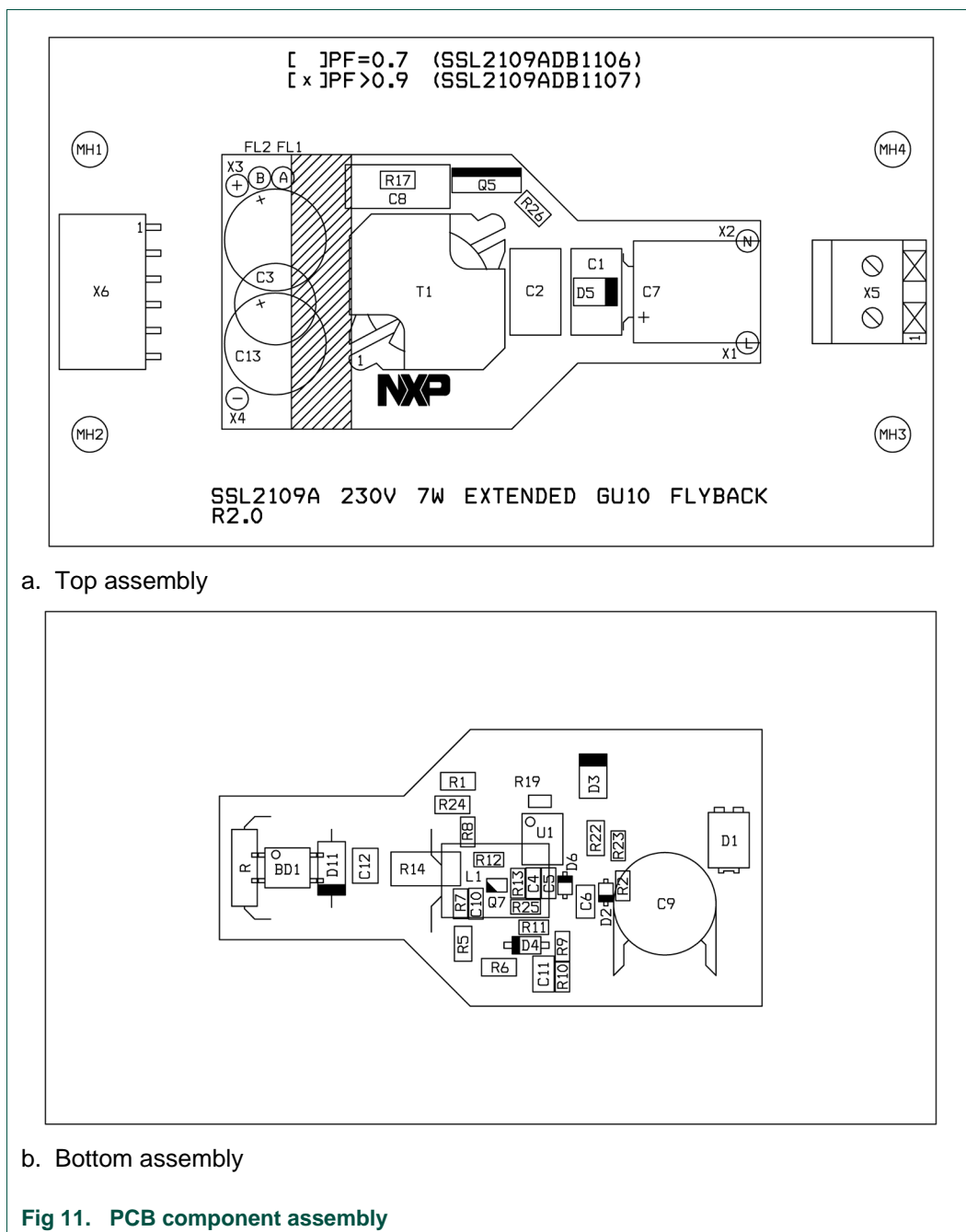

Fig 10. SSL2109ADB1107 schematic

## 8. PCB component assembly and layout

### 8.1 PCB component assembly



### 8.2 PCB layout

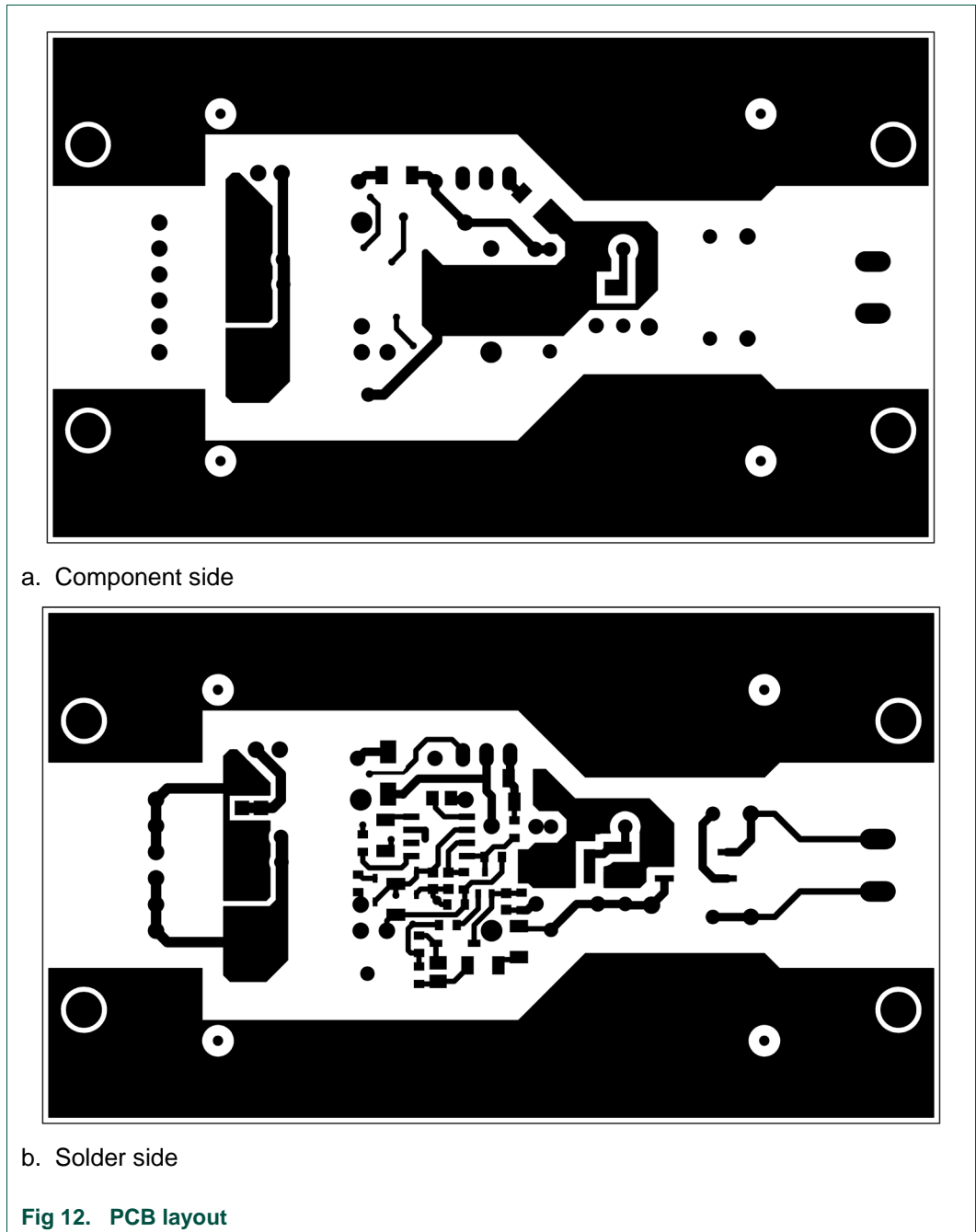



## 9. Bill of Material (BOM) SSL2109ADB1107

Table 4.

Reference	Description and values	Part number	Manufacturer
BD1	bridge rectifier; 600 V; 0.8 A	B6S-G	Comchip Technology
C1	capacitor; 100 nF; 450 V ; 10 %; metal film; radial	CL21-450V-0.1u F/K	Guang Da
C2	capacitor; 100 nF; 450 V ; 10 %; metal film; radial	CL21-450V-0.1u F/K	Guang Da
C3	capacitor; 1000 $\mu$ F; 16 V; 20 %; electrolytic; radial	ECA1CM102	Panasonic
C4	capacitor; 100 nF; 25 V; 10 %; X7R ceramic; 0603	GRM188R71E104KA01D	Murata
C5	capacitor; 100 nF; 25 V; 10 %; X7R ceramic; 0603	GRM188R71E104KA01D	Murata
C6	capacitor; 4.7 $\mu$ F; 50 V; 10 %; 1206	UMK316AB7475KL-T	Taiyo Yuden
C8	capacitor; 10 nF; 250 V; 20%; polyester; radial	ECQE2103JF	Panasonic
C9	capacitor; 2.2 nF; 4 kV; 20 %; radial	DE1E3KX222MA5B	Murata
C10	capacitor; 330 pF; 50 V; 20 %; X7R ceramic; 0603	CC0603KRX7R9BB331	Yageo
C11	capacitor; 680 nF; 25 V; 10 %; 0805	C0805C684K3NACTU	Kemet
C13	capacitor; 1000 $\mu$ F; 16 V; 20 %; electrolytic; radial	ECA1CM102	Panasonic
D1	Schottky diode; 100 V, 8 A; TO-277A	V8P10-M3/86A	Vishay
D2	switching diode; BAS21J; 300 V; 0.25 A; SOD323F	BAS21J	NXP Semiconductors
D3	fast diode; ES1J; 600 V; 1 A; DO-214AC; SMA	ES1J	Fairchild
D4	high-speed diode; 100 V; 0.4 W; SOD123	1N4148W-7-F	Diodes Inc
D6	Zener diode; 18 V; 200 mA; SOD323F	BZX384-C18	NXP
D11	TVS diode; 400V; DO-41	BZW04-342	Multicomp
FL1	solder hole for flying lead of transformer T1 (A)	-	-
FL2	solder hole for flying lead of transformer T1 (B)	-	-
L1	inductor; 3.3 mH; 100 mA; 10 $\Omega$ ; radial	22R335C	Murata
L	solder pin for MainsL	-	-
N	solder pin for MainsN	-	-
Q5	transistor; N channel MOSFET; 650 V; 3 $\Omega$	SPU02N60C3	Infineon
Q7	transistor; BC857BW; PNP; SOT323	BC857BW	NXP Semiconductors
R	resistor; 10 $\Omega$ ; 1 W; 5 %; Axial	MFP1-10R JI	Welwyn
R1	resistor; 4.7 $\Omega$ ; 0.25 W; 1 %; 1206	RC1206FR-074R7L	Yageo
R2	resistor; 10 $\Omega$ ; 0.1 W; 5 %; 0603	ERJ3GEYJ100V	Panasonic
R5	resistor; 680 k $\Omega$ ; 0.25 W; 5 %; 1206	RC1206JR-07680KL	Yageo
R6	resistor; 680 k $\Omega$ ; 0.25 W; 5 %; 1206	RC1206JR-07680KL	Yageo
R7	resistor; 560 k $\Omega$ ; 0.1 W; 1 %; 0603	CRCW0603560KFKEA	Vishay
R8	resistor; 4.7 k $\Omega$ ; 0.1 W; 1 %; 0603	CRCW06034K70FKEA	Vishay
R9	resistor; 75 k $\Omega$ ; 0.1 W; 1 %; 0603	CRCW060375K0FKEA	Vishay
R10	resistor; 33 k $\Omega$ ; 0.1 W; 1 %; 0603	CRCW060333K0FKEA	Vishay
R11	resistor; 33 k $\Omega$ ; 0.1 W; 1 %; 0603	CRCW060333K0FKEA	Vishay
R12	resistor; 470 k $\Omega$ ; 0.1 W; 1 %; 0603	CRCW0603470KFKEA	Vishay
R13	resistor; 300 k $\Omega$ ; 0.1 W; 1 %; 0603	CRCW0603300KFKEA	Vishay
R17	resistor; 220 k $\Omega$ ; 0.25 W; 5 %; 1206	RC1206JR-07220KL	Yageo
R19	resistor; 10 k $\Omega$ ; 0.125 W; 5 %; 0805	CRCW080510K0FKEA	Vishay

Reference	Description and values	Part number	Manufacturer
R22	resistor; 220 k $\Omega$ ; 0.25 W; 5 %; 1206	RC1206JR-07220KL	Yageo
R23	resistor; 33 $\Omega$ ; 0.1 W; 5 %; 0603	RC0603JR-0733RL	Yageo
R24	resistor; 3.9 $\Omega$ ; 0.25 W; 1 %; 1206	RC1206FR-073R9L	Yageo
R25	resistor; 2.2 k $\Omega$ ; 0.1 W; 5 %; 0603	CRCW06032K20FKEA	Vishay
R26	resistor; 3.3 $\Omega$ ; 0.25 W; 1 %; 1206	RC1206FR-073R3L	Yageo
T1	flyback transformer ; RM6	750313738 Rev01	Würth
U1	IC; SSL2109A; SO8	SSL2109A	Silergy Corp.
X5	Mains connector terminal block	MKDSN2,5-5.08	Phoenix Contact
X6	LED connector terminal block	BL3.36Z	Fischer Elektronik
X6	LED connector terminal block (alternative)	SSW-106-02-G-S-RA	Samtec
+	Solder pin for LED+	-	-
-	Solder pin for LED-	-	-

### 10. Transformer specification

A RM6 transformer with reinforced isolation is used with flying leads.

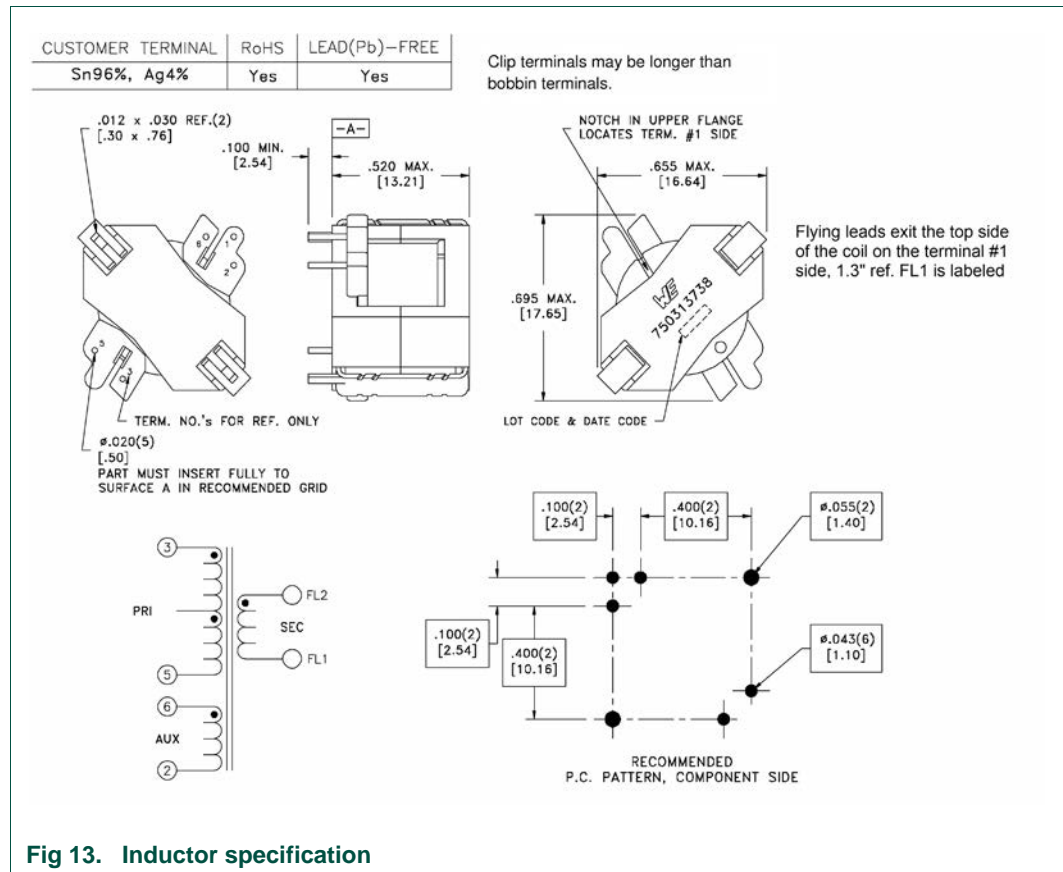

**Table 5. Electrical specification**

All values are specified at 25 °C unless otherwise specified. All values without tolerance are typical values. Reinforced insulation for a primary circuit at a working voltage of 250 V (RMS)

Parameter	Value	Comment
DCR (5-3)	1.5 Ω; ±10 %	
DCR (FL1-FL2)	130 mΩ; ±10 %	
dc resistance (2-6)	685 mΩ; ±10 %	
primary inductance (5-3)	1.5 mH; ±10 %	100 mV; 10 kHz
leakage inductance (5-3)	maximum 7.5 μH	short-circuit 2 to 6 and FL1 to FL2
primary saturation current	440mA	
turns ratio (5-3):(FL1-FL2)	5:1; ±1 %	
turns ratio (5-3):(2-6)	1.5:1; ±1 %	