

### Features

- Transient protection for lines
  - IEC 61000-4-2 (ESD)  $\pm 30\text{kV}$  (Air)
  - $\pm 30\text{kV}$  (Contact)
  - IEC 61000-4-5 (Surge) 420A (8/20 $\mu\text{s}$ )
  - IEC 61000-4-5 (Surge) 85A (5/320 $\mu\text{s}$ )
  - IEC61643-321(Surge) 28A(10/1000 $\mu\text{s}$ )
- For 15V and below operating voltage
- Excellent capability of absorbing transient surge
- Bi-directional
- Quick response to surge voltage (nS)
- Low clamping voltage
- Each I/O pin can withstand over 1000 ESD strikes for  $\pm 8\text{kV}$  contact discharge

### Description

SYS915VBHJC is designed to protect equipments from transients induced by lightning or other transient voltage events. The device will act as a crowbar when overvoltage occurs and will divert the energy away from circuit or device that is being protected.

SYS915VBHJC is in SMB package with working voltage of 15 volts. SYS915VBHJC is a bidirectional device so it is able to have functionality of 2 devices in one package, saving valuable space on board layout.

### Applications

- Desktops, Servers and Notebooks
- I/O Interfaces
- Vcc bus/CAN bus
- Consumer electronic applications
- Telecom circuits

### Mechanical Characteristics

- SMB package
- Flammability Rating: UL 94V-0
- Marking: Device code, Date code
- Packaging: Tape and Reel

### Circuit Diagram

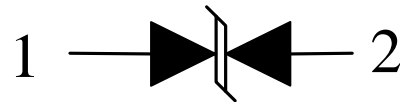

### Pin Configuration

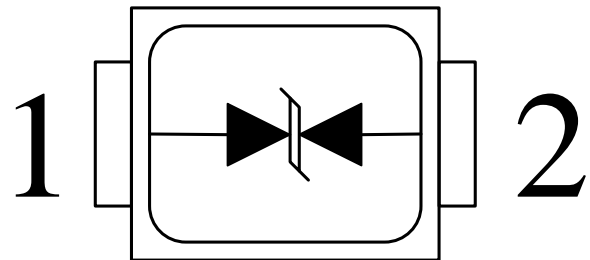

SMB  
(Top View)

## Absolute Maximum Rating

Symbol	Parameter	Value	Units
P <sub>PK</sub>	Peak Pulse Power (8/20μs)	14000	W
	Peak Pulse Power (5/320μs)	2250	
	Peak Pulse Power (10/1000μs)	650	
I <sub>PP</sub>	Peak Pulse Current (8/20μs)	420	A
	Peak Pulse Power (5/320μs)	85	
	Peak Pulse Current (10/1000μs)	28	
T <sub>OPT</sub>	Operating Temperature	-40 to +150	°C
T <sub>STG</sub>	Storage Temperature	-55 to +150	°C

## Electrical Characteristics (T<sub>A</sub> = 25°C)

Symbol	Parameter
V <sub>RWM</sub>	Nominal Reverse Working Voltage
I <sub>R</sub>	Reverse Leakage Current @ V <sub>RWM</sub>
V <sub>BR</sub>	Reverse Breakdown Voltage @ I <sub>T</sub>
I <sub>T</sub>	Test Current for Reverse Breakdown
V <sub>C</sub>	Clamping Voltage @ I <sub>PP</sub>
I <sub>PP</sub>	Peak Pulse Current
C <sub>ESD</sub>	Parasitic Capacitance
V <sub>R</sub>	Reverse Voltage
f	Small Signal Frequency

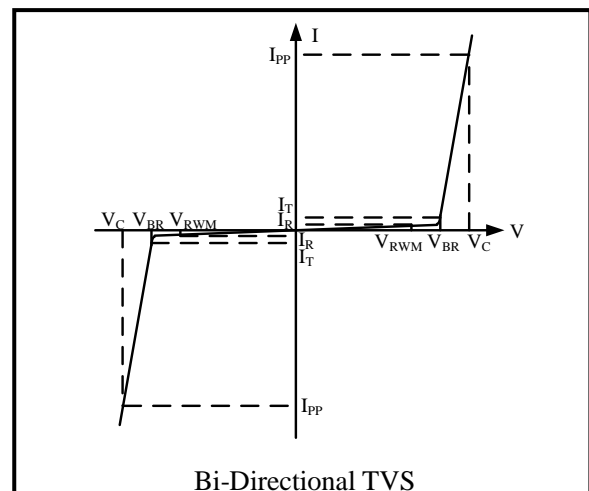

Symbol	Test Condition	Minimum	Typical	Maximum	Units
V <sub>RWM</sub>				15.5	V
I <sub>R</sub>	V <sub>RWM</sub> = 15V, T = 25°C Between Pin1 and Pin2		0.1	5	μA
V <sub>BR</sub>	I <sub>T</sub> = 1mA Between Pin1 and Pin2	16.5	17.8	21	V
V <sub>C</sub> <sup>1</sup>	I <sub>PP</sub> = 420A, t <sub>p</sub> = 8/20μs Between Pin1 and Pin2		34	36	V
V <sub>C</sub> <sup>1</sup>	I <sub>PP</sub> = 85A, t <sub>p</sub> = 5/320μs Between Pin1 and Pin2		23	25	V
V <sub>C</sub> <sup>1</sup>	I <sub>PP</sub> = 28A, t <sub>p</sub> = 10/1000μs Between Pin1 and Pin2		23	25	V
C <sub>ESD</sub> <sup>1</sup>	V <sub>R</sub> = 0V, f = 1MHz Between Pin1 and Pin2		1.5		nF

### NOTES

<sup>1</sup>Guaranteed by design and not subject to production test

## TLP of Pin1 to Pin2

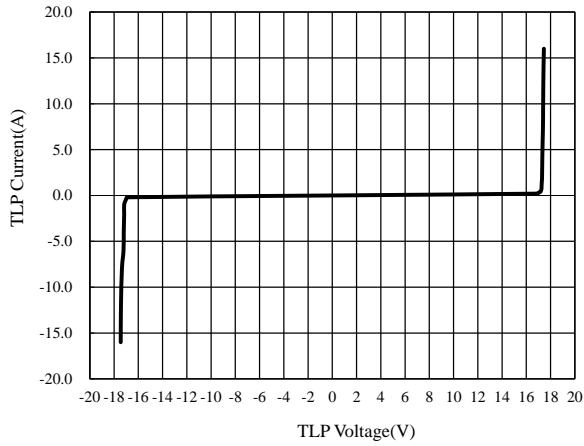

## Capacitance vs. Voltage

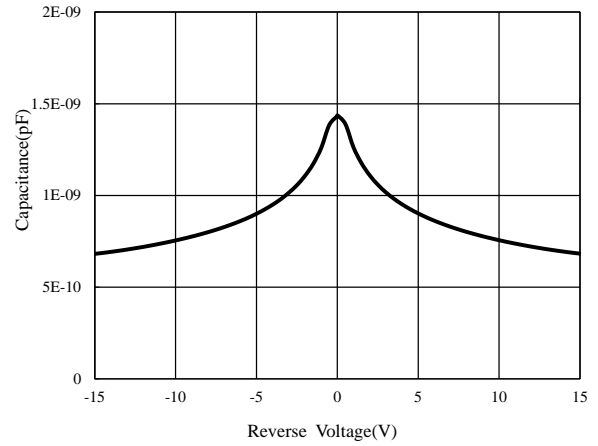

## Peak Pulse Power vs. Pulse Duration

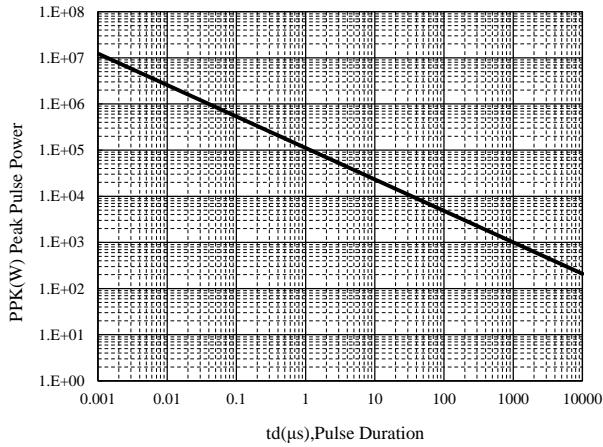

## Surge Pulse Waveform

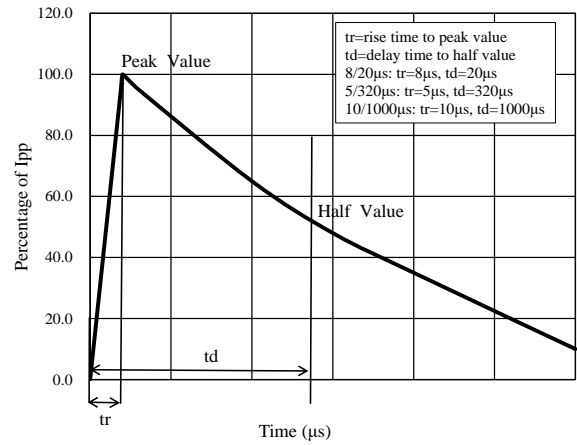

## 8/20μs Clamping Voltage vs. Peak Pulse Current

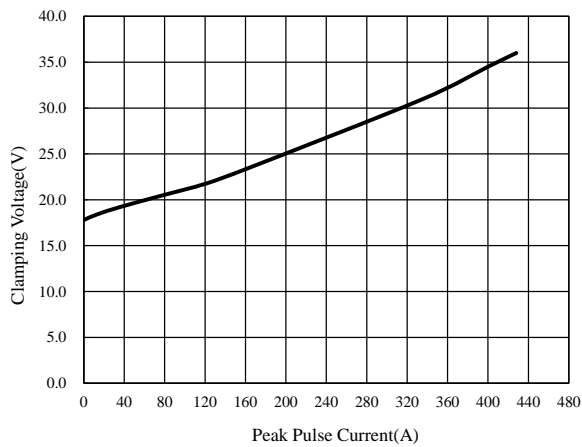

## 5/320μs Clamping Voltage vs. Peak Pulse Current

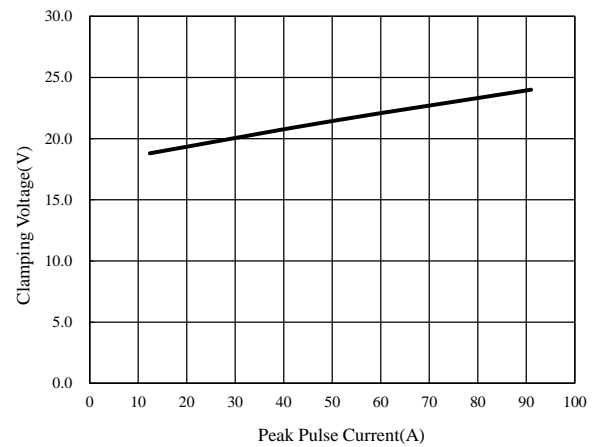

## Package Outline

- SMB Package

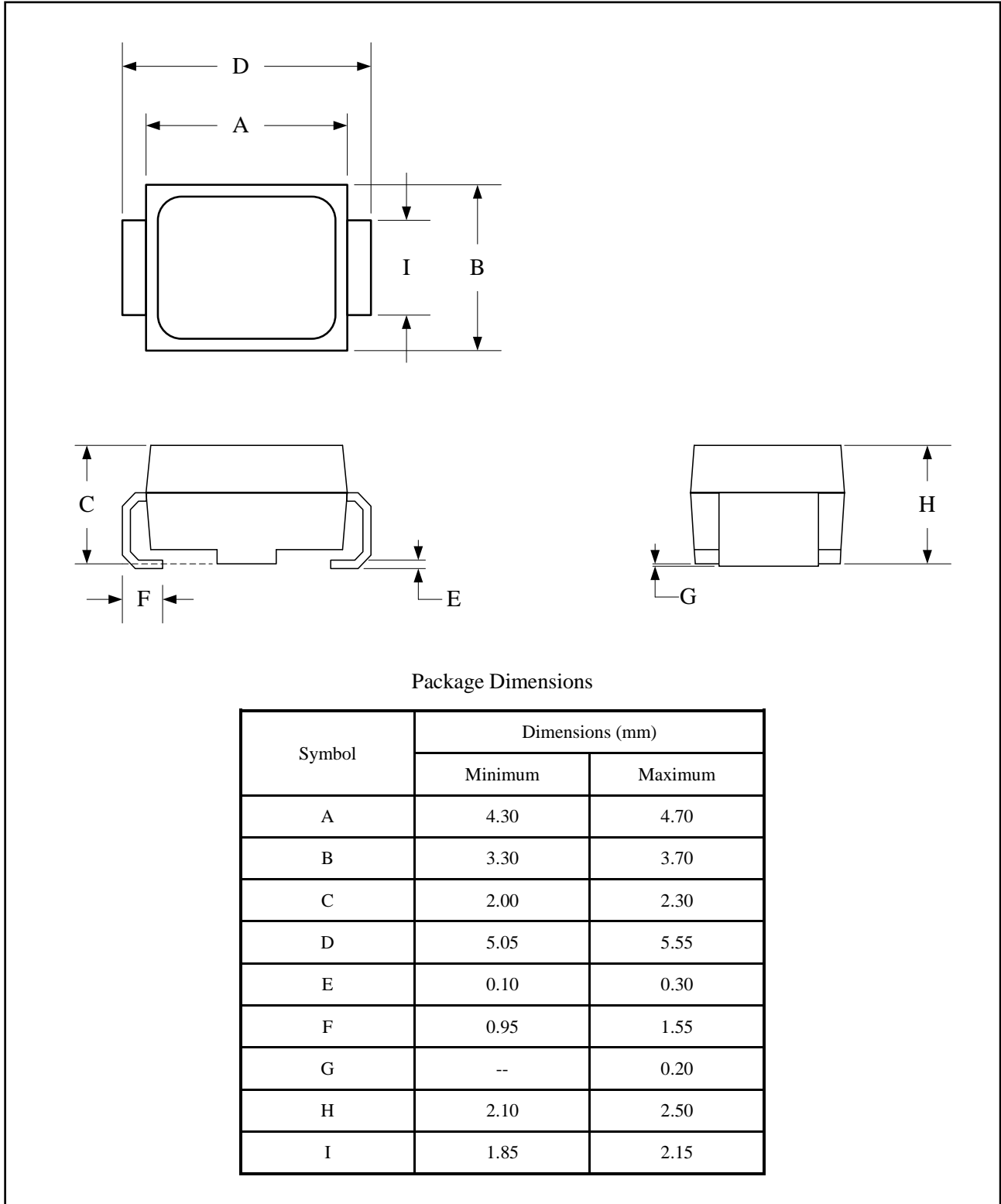

## Tape and Reel Specification

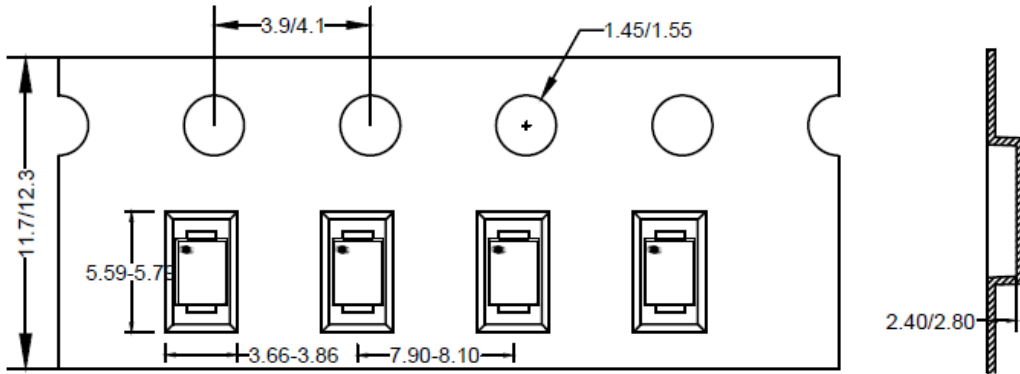

Feeding direction →

Package types	Tape width (mm)	Pocket pitch(mm)	Reel size (Inch)	Trailer * length(mm)	Leader * length (mm)	Qty per reel (pcs)
SMB	12	8	13"	160	400	3000

## Marking Codes

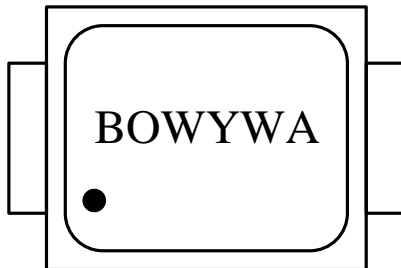

## Ordering Information

Part Number	Working Voltage	Quantity Per Reel	Reel Size
SYS915VBHJC	15V	3000pcs	13 Inch

### Note:

- (1) "BOW" is device code for SYS915VBHJC.
- (2) "YWA" is date code.