

High Efficiency 5.5V, 3A continuous, 1MHz Synchronous Step Down Regulator

General Description

The SY8003F is high-efficiency, high frequency synchronous step-down DC-DC regulator IC capable of delivering up to 3A output current. The SY8003F operates over a wide input voltage range from 2.7V to 5.5V and integrate main switch and synchronous switch with very low $R_{DS(ON)}$ to minimize the conduction loss.

Low output voltage ripple and small external inductor and capacitor sizes are achieved with 1MHz switching frequency.

SY8003F integrates reliable short circuit and over-voltage protection.

Features

- Low $R_{DS(ON)}$ for internal switches (top/bottom): 110m Ω /80m Ω
- 3A continuous load current capability
- 2.7-5.5V input voltage range
- High switching frequency minimizes the external components: 1MHz
- Internal softstart limits the inrush current
- Reliable hic-cup short circuit protection:
- 100% dropout operation
- RoHS Compliant and Halogen Free
- Compact package: DFN2X2-8.

Applications

- LCD TV
- Set Top Box
- Net PC
- Mini-Notebook PC
- Access Point Router

Ordering Information

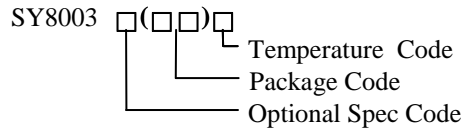

Ordering Number	Package type	Note
SY8003FDFC	DFN2x2-8	

Typical Applications

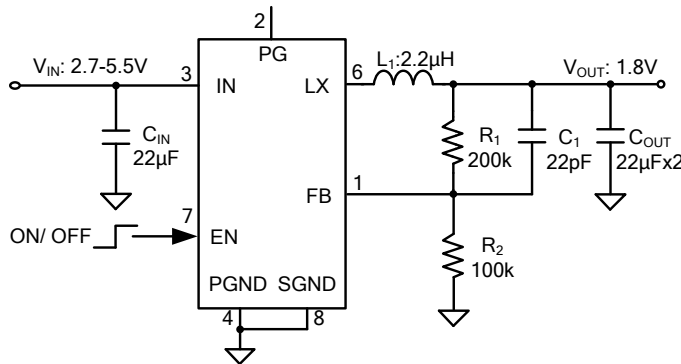

Figure 1. Schematic diagram

Efficiency vs. Load Current

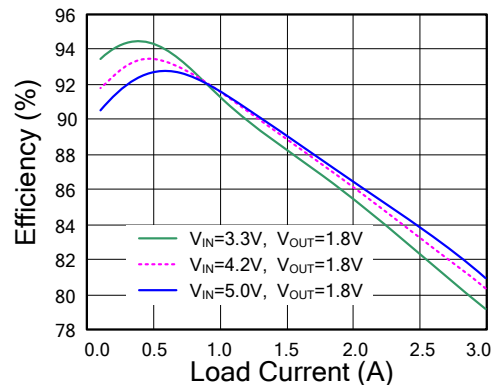
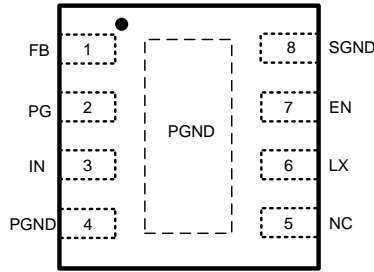

Figure 2. Efficiency vs Load Current

Pinout (top view)



Part Number	Package type	Top Mark [®]
SY8003FDFC	DFN2x2-8	Ua xyz

Note ①: x=year code, y=week code, z=lot number code.

Pin Name	Pin Number	Pin Description
EN	7	Enable control. Pull high to turn on. Do not leave it floating.
PGND	4/Exposed Paddle	Power ground pin.
SGND	8	Signal ground pin.
LX	6	Inductor pin. Connect this pin to the switching node of inductor.
IN	3	Power input pin. Decouple this pin to GND pin with at least 10μF ceramic cap.
PG	2	Power good indicator(Open drain output). Low if the output < 90% of regulation voltage or >120% regulation voltage; High otherwise. Connect a pull-up resistor to the input.
FB	1	Output Feedback Pin. Connect this pin to the center point of the output resistor divider (as shown in Figure 1) to program the output voltage: $V_{out}=0.6*(1+R_1/R_2)$.
NC	5	No connection.

Block Diagram

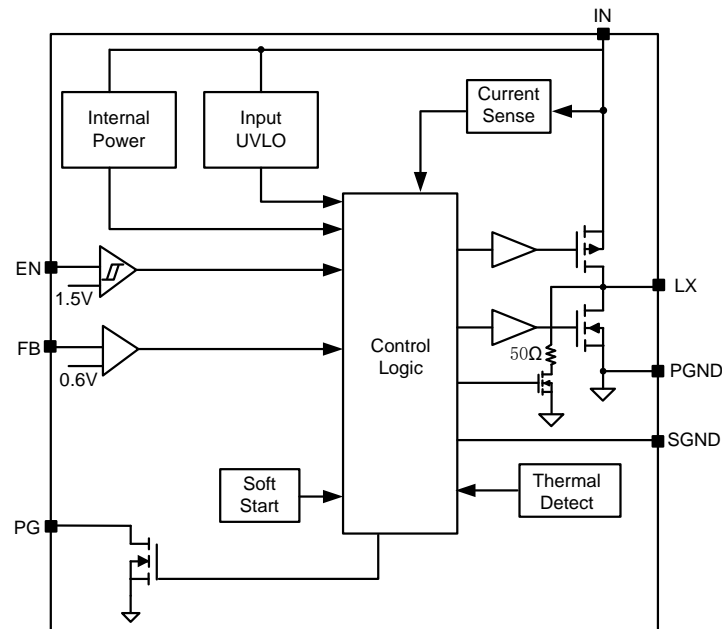



Absolute Maximum Ratings (Note 1)

Supply Input Voltage	-0.3V to 6.0V
Enable, FB Voltage	-0.3V to $V_{IN} + 0.6V$
LX Voltage	-0.3V ^(*1) to 6V ^(*2)
Power Dissipation, PD @ TA = 25°C DFN2x2-8 ,	1W
Package Thermal Resistance (Note 2)	
θ_{JA}	120°C/W
θ_{JC}	8.2°C/W
Junction Temperature Range	150°C
Lead Temperature (Soldering, 10 sec.)	260°C
Storage Temperature Range	65°C to 150°C

(*1) LX Voltage tested down to -5V<10ns
(*2) LX Voltage tested up to +7V<50ns

Recommended Operating Conditions (Note 3)

Supply Input Voltage	2.7V to 5.5V
Junction Temperature Range	-40°C to 125°C
Ambient Temperature Range	-40°C to 85°C

Electrical Characteristics

($V_{IN} = 5V$, $V_{OUT} = 2.5V$, $L = 2.2\mu H$, $C_{OUT} = 22\mu F$, $T_A = 25^\circ C$, unless otherwise specified)

Parameter	Symbol	Test Conditions	Min	Typ	Max	Unit
Input Voltage Range	V_{IN}		2.7		5.5	V
Quiescent Current	I_Q	$I_{OUT}=0$, $V_{FB}=V_{REF} \cdot 105\%$		55		μA
Shutdown Current	I_{SHDN}	EN=0		0.1	1	μA
Feedback Reference Voltage	V_{REF}		0.591	0.6	0.609	V
PFET RON	$R_{DS(ON),P}$			110		m Ω
NFET RON	$R_{DS(ON),N}$			80		m Ω
PFET Current Limit	I_{LIM}		3.5			A
EN rising threshold	V_{ENH}		1.5			V
EN falling threshold	V_{ENL}				0.4	V
EN Leakage current	I_{EN}		-1		1	μA
Input UVLO threshold	V_{UVLO}				2.65	V
UVLO hysteresis	V_{HYS}			0.2		V
Oscillator Frequency	F_{OSC}	$I_{OUT}=500mA$	0.8	1	1.2	MHz
PG High Delay Time				0.1	1	μS
PG Rising Threshold	$V_{FB,HV}$			0.54		V
PG Under-voltage Threshold	$V_{FB,LV}$			0.54		V
PG Under-voltage Delay Time				20		μS
PG Over-voltage Threshold	$V_{FB,OV}$		0.69	0.72	0.75	V
Over-voltage Protection Threshold	V_{OVP}		0.69	0.72	0.75	V
Over-voltage Deglitch Timeout	t_{OV}		10	20	30	μs
Short Circuit Protection Delay Time	$t_{DELAY-SC}$			20		μs
Min ON Time				75		ns
Max Duty Cycle			100			%
Soft Start Time	t_{SS}		0.84	1.2	1.56	ms
Output Discharge Switch On Resistance	R_{DISCH}			50		Ω
Thermal Shutdown Temperature	T_{SD}			160		$^\circ C$

Note 1: Stresses beyond the “Absolute Maximum Ratings” may cause permanent damage to the device. These are stress ratings only. Functional operation of the device at these or any other conditions beyond those indicated in the operational sections of the specification is not implied. Exposure to absolute maximum rating conditions for extended periods may affect device reliability.

Note 2: Test condition: Device mounted on 2” x 2” FR-4 substrate PCB, 2oz copper, with minimum recommended pad on top layer and thermal vias to bottom layer ground plane.

Note 3: The device is not guaranteed to function outside its operating conditions.

Typical Performance Characteristics

Efficiency vs. Load Current

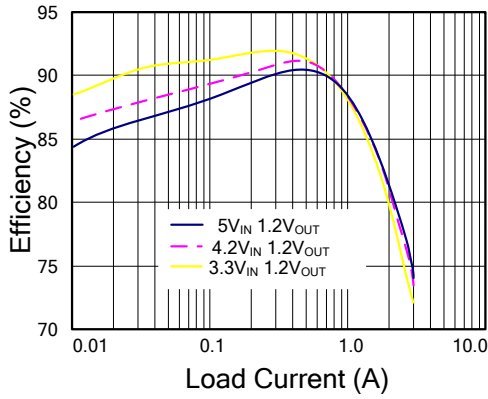

Efficiency vs. Load Current

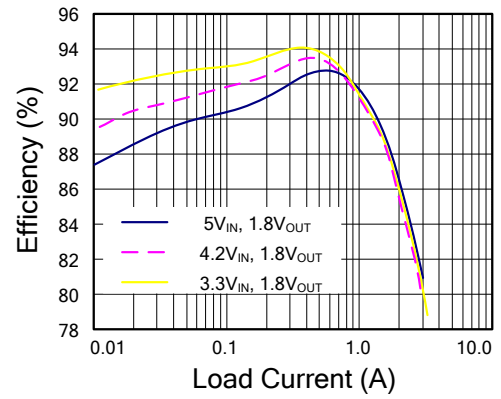

Efficiency vs. Load Current

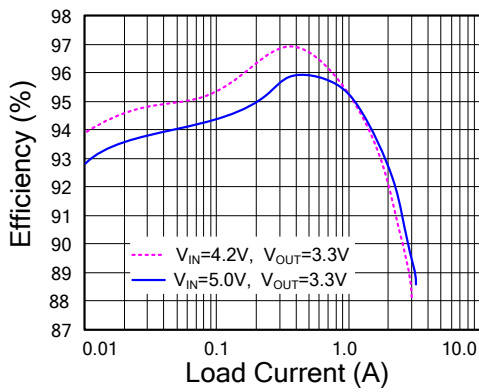

Output Ripple

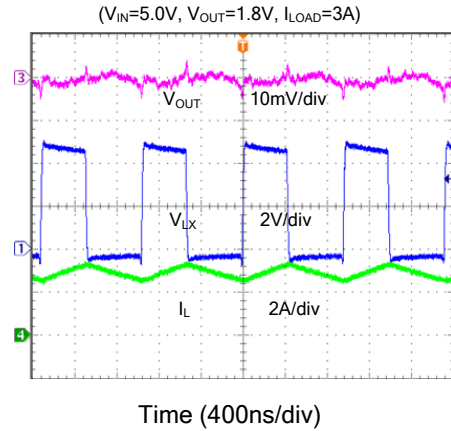

Startup from Enable

($V_{IN} = 5.0V$, $V_{OUT} = 1.8V$, $I_{LOAD} = 3.0A$)

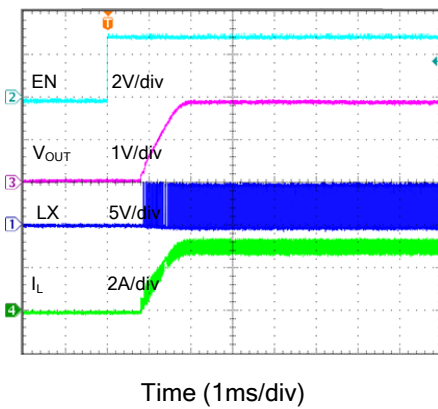

Shutdown from Enable

($V_{IN} = 5.0V$, $V_{OUT} = 1.8V$, $I_{LOAD} = 3.0A$)

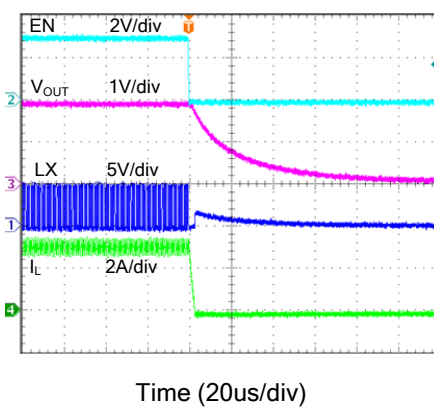

Load Transient
 ($V_{IN}=5.0V$, $V_{OUT}=1.8V$, $I_{LOAD}=0-1.5A$)

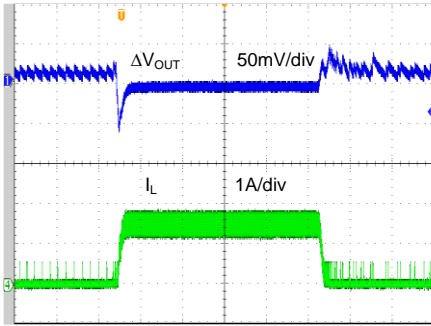

Time (100μs/div)

Load Transient
 ($V_{IN}=5.0V$, $V_{OUT}=1.8V$, $I_{LOAD}=0.3-3.0A$)

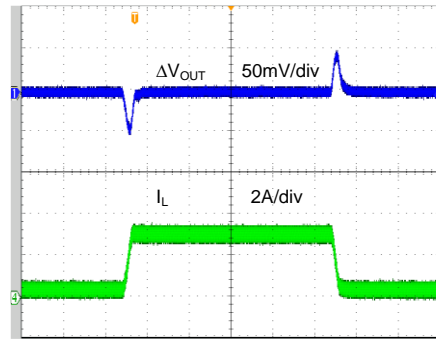

Time (100μs/div)

Short Circuit Protection
 ($V_{IN}=5.0V$, $V_{OUT}=1.8V$, $I_{LOAD}=0A$ -Short SY8003)

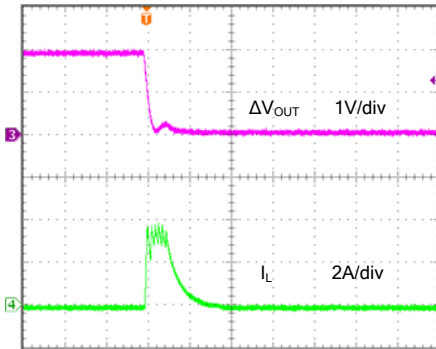

Time (40μs/div)

Short Circuit Protection
 ($V_{IN}=5.0V$, $V_{OUT}=1.8V$, $I_{LOAD}=3.0A$ -Short SY8003)

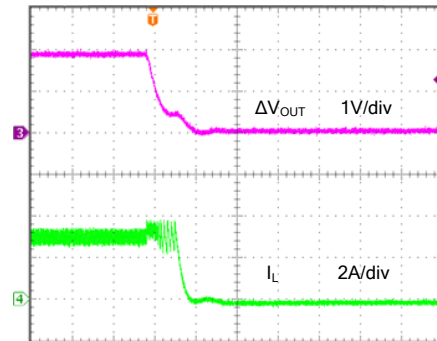

Time (40μs/div)

Short Circuit Protection
 ($V_{IN}=5.0V$, $V_{OUT}=1.8V$, $I_{LOAD}=0A$ -Short, SY8003A)

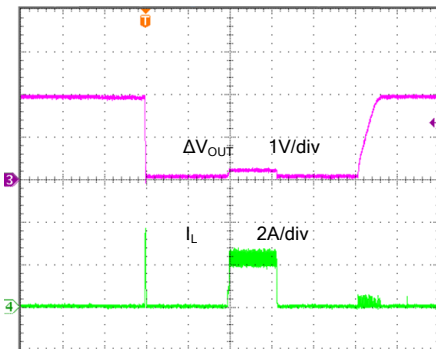

Time (2ms/div)

Short Circuit Protection
 ($V_{IN}=5.0V$, $V_{OUT}=1.8V$, $I_{LOAD}=3.0A$ -Short, SY8003A)

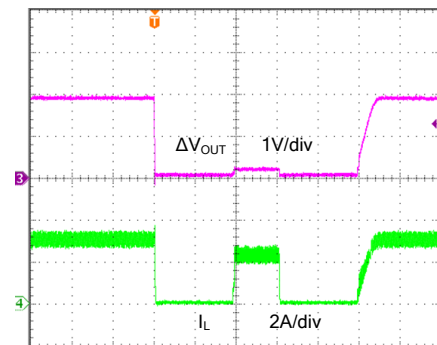

Time (2ms/div)

Operation Principle

SY8003F is a synchronous buck regulator IC that integrates the PWM control, top and bottom switches on the same die to minimize the switching transition loss and conduction loss. With ultra low $R_{DS(ON)}$ power switches and proprietary PWM control, this regulator IC can achieve the highest efficiency and the highest switch frequency simultaneously to minimize the external inductor and capacitor size, and thus achieving the minimum solution footprint.

Short Circuit Protection

The frequency is folded back to about 30% of the nominal frequency and the current limit is folded back to 3.0A to prevent the inductor current from runaway and to reduce the power dissipation of the IC under short circuit conditions.

Feedback resistor dividers R1 and R2:

Choose R_1 and R_2 to program the proper output voltage. To minimize the power consumption under light loads, it is desirable to choose large resistance values for both R_1 and R_2 . A value of between 10k and 1M is highly recommended for both resistors. If V_{OUT} is 1.8V, $R_1=100k$ is chosen, then R_2 can be calculated to be 50k.

$$R_2 = \frac{0.6V}{V_{OUT} - 0.6V} R_1 (\Omega)$$

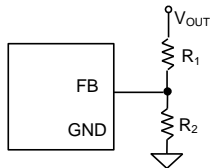

Input capacitor CIN:

This ripple current through input capacitor is calculated as:

$$I_{CIN_RMS} = I_{OUT} \times \sqrt{D(1-D)}$$

This formula has a maximum at $V_{IN}=2V_{OUT}$ condition, where $I_{CIN_RMS}=I_{OUT}/2$. This simple worst-case condition is commonly used for DC/DC design.

With the maximum load current at 3.0A. A typical X5R or better grade ceramic capacitor with 6.3V rating and more than 1 pcs 22 μ F capacitor can handle this ripple current well. To minimize the potential noise problem, ceramic capacitor should really be placed close to the IN and GND pins. Care should be

taken to minimize the loop area formed by CIN, and IN/GND pins

Output capacitor COUT:

The output capacitor is selected to handle the output ripple noise requirements. Both steady state ripple and transient requirements must be taken into consideration when selecting this capacitor. For the best performance, it is recommended to use X5R or better grade ceramic capacitor with 6.3V rating and greater than 22 μ F capacitance.

Output inductor L:

There are several considerations in choosing this inductor.

- 1) Choose the inductance to provide the desired ripple current. It is suggested to choose the ripple current to be about 40% of the maximum output current. The inductance is calculated as:

$$L = \frac{V_{OUT}(1 - V_{OUT}/V_{IN,MAX})}{F_{SW} \times I_{OUT,MAX} \times 40\%}$$

where F_{sw} is the switching frequency and $I_{OUT,MAX}$ is the maximum load current.

The SY8003F regulator IC is quite tolerant of different ripple current amplitude. Consequently, the final choice of inductance can be slightly off the calculation value without significantly impacting the performance.

- 2) The saturation current rating of the inductor must be selected to be greater than the peak inductor current under full load conditions.

$$I_{SAT, MIN} > I_{OUT, MAX} + \frac{V_{OUT}(1 - V_{OUT}/V_{IN,MAX})}{2 \cdot F_{SW} \cdot L}$$

- 3) The DCR of the inductor and the core loss at the switching frequency must be low enough to achieve the desired efficiency requirement. It is desirable to choose an inductor with $DCR < 50m\Omega$ to achieve a good overall efficiency.

Enable Operation

Pulling the EN pin low (<0.4V) will shut down the device. During shut down mode, the SY8003F shutdown current drops to lower than 0.1uA. Driving the EN pin high (>1.5V) will turn on the IC again.

Load Transient Considerations:

The SY8003F regulator IC integrates the compensation components to achieve good stability and fast transient responses. In some applications, adding a 22pF ceramic cap in parallel with R_1 may further speed up the load transient responses and is

thus recommended for applications with large load transient step requirements.

Layout Design:

The layout design of SY8003F regulator is relatively simple. For the best efficiency and minimum noise problems, we should place the following components close to the IC: C_{IN} , L, R_1 and R_2 .

- 1) It is desirable to maximize the PCB copper area connecting to GND pin to achieve the best thermal and noise performance. If the board space allowed, a ground plane is highly desirable.
- 2) C_{IN} must be close to Pins IN and GND. The loop area formed by C_{IN} and GND must be minimized.
- 3) The PCB copper area associated with LX pin must be minimized to avoid the potential noise problem.
- 4) The components R_1 , R_2 , and the trace connecting to the FB pin must NOT be adjacent to the LX net on the PCB layout to avoid the noise problem.

- 4) If the system chip interfacing with the EN pin has a high impedance state at shutdown mode and the IN pin is connected directly to a power source such as a LiIon battery, it is desirable to add a pull down $1M\Omega$ resistor between the EN and GND pins to prevent the noise from falsely turning on the regulator at shutdown mode.

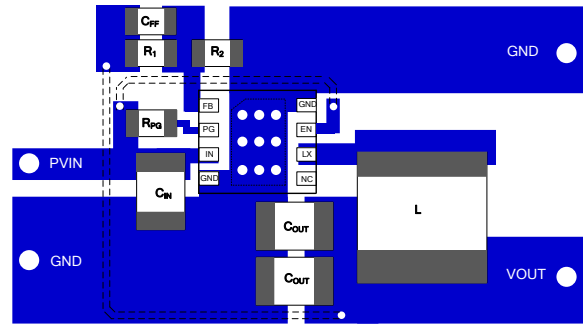

DFN2x2-8 Package Outline

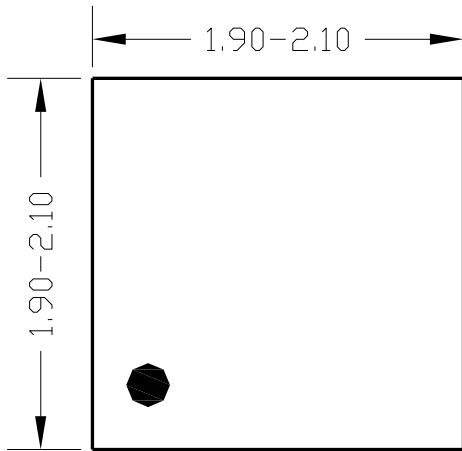

Top View

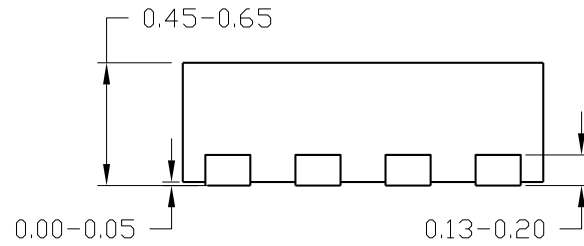

Side View

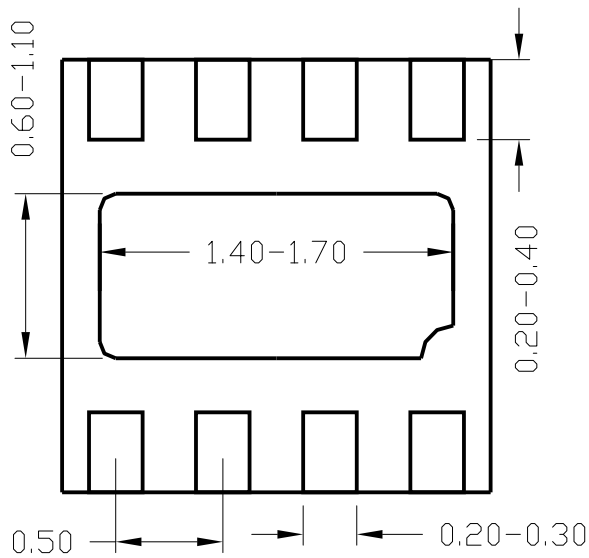

Bottom View

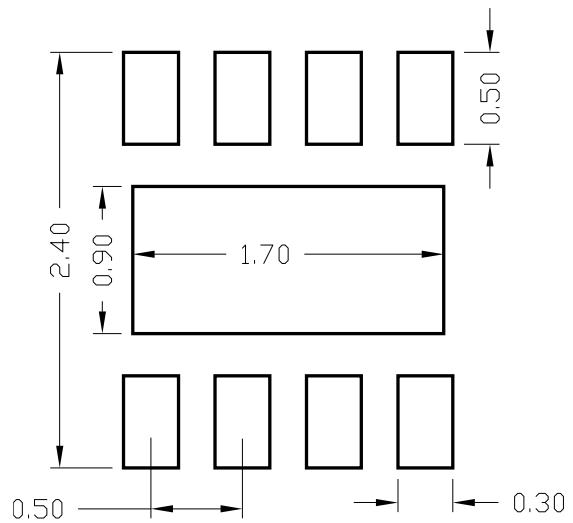

PCB Layout (Reference Only)

Notes: **All dimension in millimeter**
 All dimension don't include mold flash & metal burr

Taping & Reel Specification

1. DFN2x2

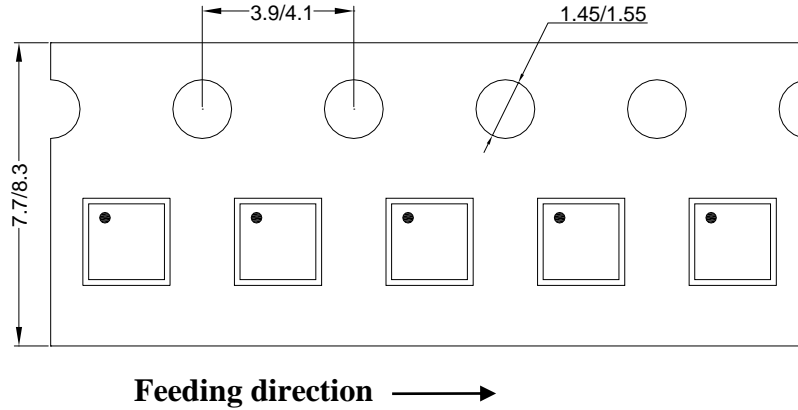

2. Carrier Tape & Reel specification for packages

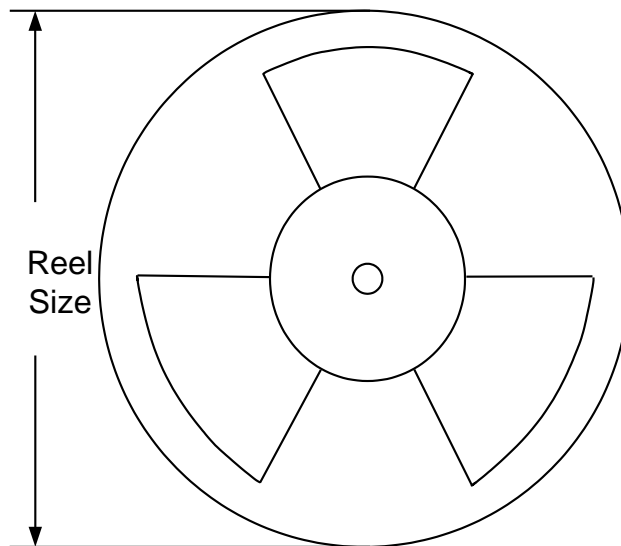

Package types	Tape width (mm)	Pocket pitch(mm)	Reel size (Inch)	Trailer length(mm)	Leader length (mm)	Qty per reel
DFN2x2	8	4	7"	400	160	3000

3. Others: NA

**IMPORTANT NOTICE**

1. **Right to make changes.** Silergy and its subsidiaries (hereafter Silergy) reserve the right to change any information published in this document, including but not limited to circuitry, specification and/or product design, manufacturing or descriptions, at any time and without notice. This document supersedes and replaces all information supplied prior to the publication hereof. Buyers should obtain the latest relevant information before placing orders and should verify that such information is current and complete. All semiconductor products are sold subject to Silergy's standard terms and conditions of sale.

2. **Applications.** Application examples that are described herein for any of these products are for illustrative purposes only. Silergy makes no representation or warranty that such applications will be suitable for the specified use without further testing or modification. Buyers are responsible for the design and operation of their applications and products using Silergy products. Silergy or its subsidiaries assume no liability for any application assistance or designs of customer products. It is customer's sole responsibility to determine whether the Silergy product is suitable and fit for the customer's applications and products planned. To minimize the risks associated with customer's products and applications, customer should provide adequate design and operating safeguards. Customer represents and agrees that it has all the necessary expertise to create and implement safeguards which anticipate dangerous consequences of failures, monitor failures and their consequences, lessen the likelihood of failures that might cause harm and take appropriate remedial actions. Silergy assumes no liability related to any default, damage, costs or problem in the customer's applications or products, or the application or use by customer's third-party buyers. Customer will fully indemnify Silergy, its subsidiaries, and their representatives against any damages arising out of the use of any Silergy components in safety-critical applications. It is also buyers' sole responsibility to warrant and guarantee that any intellectual property rights of a third party are not infringed upon when integrating Silergy products into any application. Silergy assumes no responsibility for any said applications or for any use of any circuitry other than circuitry entirely embodied in a Silergy product.

3. **Limited warranty and liability.** Information furnished by Silergy in this document is believed to be accurate and reliable. However, Silergy makes no representation or warranty, expressed or implied, as to the accuracy or completeness of such information and shall have no liability for the consequences of use of such information. In no event shall Silergy be liable for any indirect, incidental, punitive, special or consequential damages, including but not limited to lost profits, lost savings, business interruption, costs related to the removal or replacement of any products or rework charges, whether or not such damages are based on tort or negligence, warranty, breach of contract or any other legal theory. Notwithstanding any damages that customer might incur for any reason whatsoever, Silergy' aggregate and cumulative liability towards customer for the products described herein shall be limited in accordance with the Standard Terms and Conditions of Sale of Silergy.

4. **Suitability for use.** Customer acknowledges and agrees that it is solely responsible for compliance with all legal, regulatory and safety-related requirements concerning its products, and any use of Silergy components in its applications, notwithstanding any applications-related information or support that may be provided by Silergy. Silergy products are not designed, authorized or warranted to be suitable for use in life support, life-critical or safety-critical systems or equipment, nor in applications where failure or malfunction of an Silergy product can reasonably be expected to result in personal injury, death or severe property or environmental damage. Silergy assumes no liability for inclusion and/or use of Silergy products in such equipment or applications and therefore such inclusion and/or use is at the customer's own risk.

5. **Terms and conditions of commercial sale.** Silergy products are sold subject to the standard terms and conditions of commercial sale, as published at <http://www.silergy.com/stdterms>, unless otherwise agreed in a valid written individual agreement specifically agreed to in writing by an authorized officer of Silergy. In case an individual agreement is concluded only the terms and conditions of the respective agreement shall apply. Silergy hereby expressly objects to and denies the application of any customer's general terms and conditions with regard to the purchase of Silergy products by the customer.

6. **No offer to sell or license.** Nothing in this document may be interpreted or construed as an offer to sell products that is open for acceptance or the grant, conveyance or implication of any license under any copyrights, patents or other industrial or intellectual property rights. Silergy makes no representation or warranty that any license, either express or implied, is granted under any patent right, copyright, mask work right, or other intellectual property right. Information published by Silergy regarding third-party products or services does not constitute a license to use such products or services or a warranty or endorsement thereof. Use of such information may require a license from a third party under the patents or other intellectual property of the third party, or a license from Silergy under the patents or other intellectual property of Silergy.

For more information, please visit: www.silergy.com

© 2018 Silergy Corp.

All Rights Reserved.