



High Efficiency Fast Response, 4A, 23V Input Synchronous Step Down Regulator



General Description

The SY8284 develops a high efficiency synchronous step-down DC/DC regulator capable of delivering 4A current over a wide input voltage range of 4V to 23V.

Silergy's proprietary Instant-PWM™ fast-response, constant-on-time (COT) PWM control method supports high input/output voltage ratios (low duty cycles), and fast transient response while maintaining a near constant operating frequency over line, load and output voltage ranges. This control method provides stable operation without complex compensation and even with low ESR ceramic capacitors.

Internal 85mΩ power and 35mΩ synchronous rectifier switches provide excellent efficiency over a range of applications, especially for low output voltages and low duty cycles. SY8284 also integrates a bypass switch which allows the IC to be powered by external DC source. Cycle-by-cycle current limit, input under voltage lock-out, internal soft-start, output under voltage protection and over voltage protection, and thermal shutdown provide safe operation in all operating conditions. The SY8284 is available in a compact QFN3×3-20 package.

Ordering Information

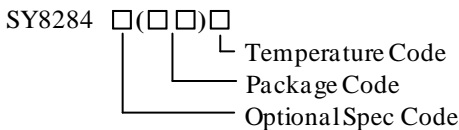

Ordering Number	Package type	Note
SY8284RAC	QFN3×3-20	--

Features

- Low $R_{DS(ON)}$ for Internal Switches (Top/Bottom): 85/35mΩ
- Wide Input Voltage range: 4~23V
- Instant PWM Architecture to Achieve Fast Transient Responses
- Internal 600μs Soft-start Limits the Inrush Current
- Pseudo-constant Frequency: 500kHz
- 4A Output Current Capability
- ±1% Internal Reference Voltage
- Optional Bypass Input
- Power Good Indicator
- Output Discharge Function
- Output Current Limit Protection
- Latch off Mode Output Under Voltage Protection
- Latch off Mode Output Over Voltage Protection
- Programmable Bottom FET Current Limit
- Input Under Voltage Lock-out(UVLO)
- Latch off Mode Over Temperature Protection
- RoHS Compliant and Halogen Free
- Compact Package: QFN3×3-20

Applications

- LCD-TV/Net-TV/3DTV
- Set Top Box
- Notebook
- High Power AP

Typical Applications

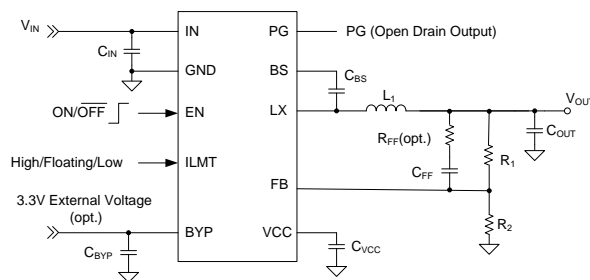

Figure 1. Schematic

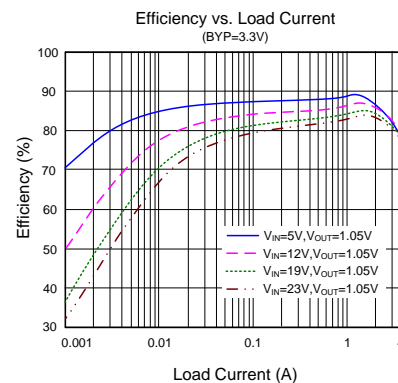
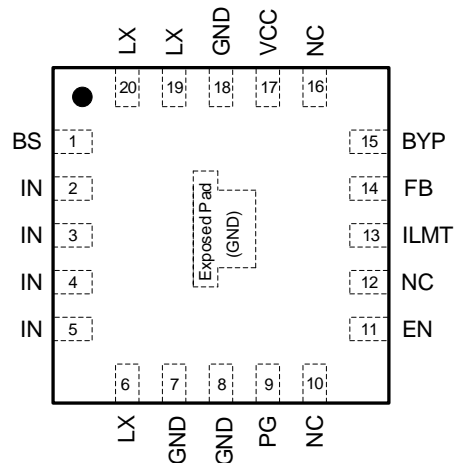

Figure 2. Efficiency vs. Load Current

Pinout (top view)



(QFN3×3-20)

Top Mark: BIDxyz, (Device code: BID, *x*=year code, *y*=week code, *z*=lot number code)

Pin Name	Pin Number	Pin Description
BS	1	Boot-strap pin. Supply high side gate driver. Connect a 0.1μF ceramic capacitor between BS and LX pin.
IN	2, 3, 4, 5	Input pin. Decouple this pin to GND pin with at least a 10μF ceramic capacitor.
LX	6, 19, 20	Inductor pin. Connect this pin to the switching node of inductor.
GND	7, 8, 18, EP	Ground pin.
PG	9	Power good Indicator. Open drain output when the output voltage is within 90% to 120% of regulation point.
NC	10, 12, 16	Do not connect.
EN	11	Enable pin. Pull this pin high to turn on IC. Do not leave this pin floating.
ILMT	13	Output current limit threshold selection.
FB	14	Output feedback pin. Connect to the center point of resistor divider.
BYP	15	External 3.3V bypass power supply input. Decouple this pin to GND with a 1μF ceramic capacitor. Leave this pin floating if it is not used.
VCC	17	Internal 3.3V LDO output. Power supply for internal analog circuits and driving circuit. Decouple this pin to GND with a 2.2μF ceramic capacitor.

Block Diagram

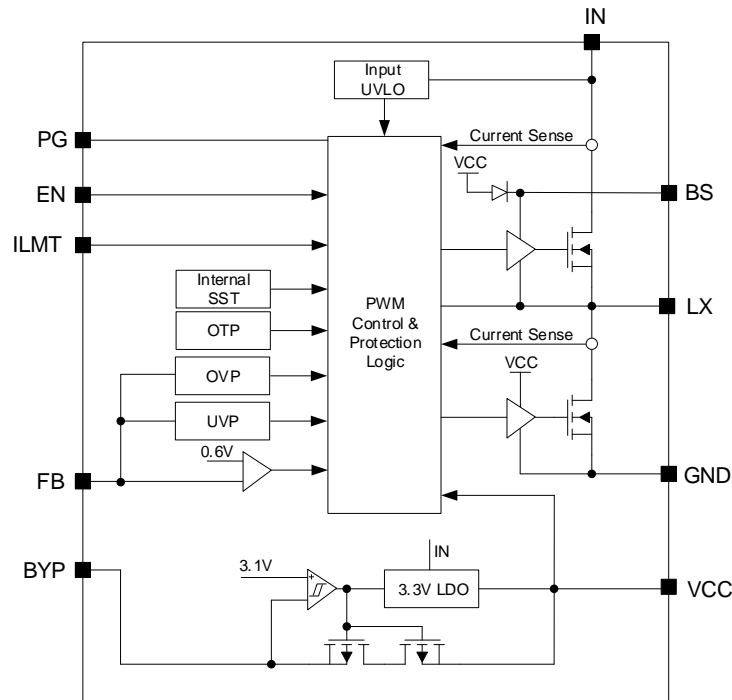

Figure 3. Block Diagram

Absolute Maximum Ratings (Note 1)

Supply Input Voltage	-----	-0.3V to 25V
EN, ILMT, PG, LX Voltage	-----	-0.3V to IN+0.3V
BYP Voltage	-----	-0.3V to 6V
BS-LX, VCC, FB Voltage	-----	-0.3V to 4V
Maximum Power Dissipation, P _{D,MAX} @ T _A = 25°C QFN3×3-20	-----	3.33W
Package Thermal Resistance (Note 2)		
θ _{JA} , QFN3×3-20	-----	30°C/W
θ _{JC} , QFN3×3-20	-----	4.5°C/W
Junction Temperature Range	-----	-40°C to 150°C
Lead Temperature (Soldering, 10 sec.)	-----	260°C
Storage Temperature Range	-----	-65°C to 150°C
Dynamic LX Voltage in 10ns Duration	-----	IN+3V to GND-5V

Recommended Operating Conditions (Note 3)

Supply Input Voltage	-----	4V to 23V
Junction Temperature Range	-----	-40°C to 125°C
Ambient Temperature Range	-----	-40°C to 85°C

Electrical Characteristics

($V_{IN} = 12V$, $C_{OUT} = 44\mu F$, $T_A = 25^\circ C$, $I_{OUT} = 1A$ unless otherwise specified)

Parameter	Symbol	Test Conditions	Min	Typ	Max	Unit
Input Voltage Range	V_{IN}		4		23	V
Input UVLO Threshold	V_{UVLO}	V_{IN} Rising			3.9	V
Input UVLO Hysteresis	V_{HYS}			0.3		V
Quiescent Current	I_Q	EN=1, $I_{OUT}=0A$, $V_{OUT}=V_{SET}\times 105\%$		121	145	μA
Shutdown Current	I_{SHDN}	EN=0		6	10	μA
Feedback Reference Voltage	V_{REF}		0.594	0.6	0.606	V
FB Input Current	I_{FB}	$V_{FB}=1V$	-50		50	nA
Top FET $R_{DS(ON)}$	$R_{DS(ON)1}$			85		m Ω
Bottom FET $R_{DS(ON)}$	$R_{DS(ON)2}$			35		m Ω
Output Discharge Current	I_{DIS}	$V_{OUT}=1.2V$		50		mA
Top FET Current Limit	$I_{LMT, TOP}$		10			A
Bottom FET Current Limit	$I_{LMT, BOT}$	ILMT=Low	5			A
		ILMT=Floating	6.5			A
		ILMT=High	8			A
Soft Start Time	t_{SS}	V_{OUT} from 0% to 100% V_{SET}		600		μs
EN Rising Threshold	$V_{EN, R}$		1.08	1.2	1.32	V
EN Falling Threshold	$V_{EN, F}$		0.72	0.8	0.88	V
ILMT Rising Threshold	$V_{ILMT, R}$		$V_{CC}-0.7$			V
ILMT Falling Threshold	$V_{ILMT, F}$				0.45	V
Switching Frequency	f_{SW}	$V_{OUT}=1.2V$, CCM	410	500	590	kHz
Min ON Time	$t_{ON, MIN}$	$V_{IN}=V_{INMAX}$		50		ns
Min OFF Time	$t_{OFF, MIN}$			150		ns
VCC Output Voltage	V_{CC}	VCC with 1mA Load	3.15	3.3	3.45	V
Output Over Voltage Threshold	V_{OVP}	V_{FB} rising	115	120	125	% V_{REF}
Output Over Voltage Hysteresis	$V_{OVP, HYS}$			5		% V_{REF}
Output OVP Delay	$t_{OVP, DLY}$			25		μs
Output Under Voltage Protection Threshold	V_{UVP}	V_{FB} falling	55	60	65	% V_{REF}
Output UVP Delay	$t_{UVP, DLY}$			250		μs
Power Good Threshold	V_{PG}	V_{FB} rising (good)	87	90	93	% V_{REF}
Power Good Hysteresis	$V_{PG, HYS}$			5		% V_{REF}
Power Good Delay	$t_{PG, R}$	Low to high		250		μs
	$t_{PG, F}$	High to low		10		μs
Bypass Switch $R_{DS(ON)}$	$R_{DS(ON), BYP}$			1.5		Ω
Bypass Switch Turn-on Voltage	V_{BYP}		2.97	3.1	3.21	V
Bypass Switch Switchover Hysteresis	$V_{BYP, HYS}$			0.18		V

Bypass Switch OVP Threshold	$V_{BYP,OV P}$			120		%V _{CC}
Bypass Switch OVP Hysteresis	$V_{BYP,OV P,HYS}$			5		%V _{CC}
Thermal Shutdown Temperature	T_{SD}	T_J rising		150		°C
Thermal Shutdown Hysteresis	T_{HYS}			15		°C

Note 1: Stresses beyond the “Absolute Maximum Ratings” may cause permanent damage to the device. These are stress ratings only. Functional operation of the device at these or any other conditions beyond those indicated in the operational sections of the specification is not implied. Exposure to absolute maximum rating conditions for extended periods may affect device reliability

Note 2: Package thermal resistance is measured in the natural convection at $T_A = 25^\circ\text{C}$ on a four-layer Silergy Evaluation Board.

Note 3: The device is not guaranteed to function outside its operating conditions.

Typical Performance Characteristics

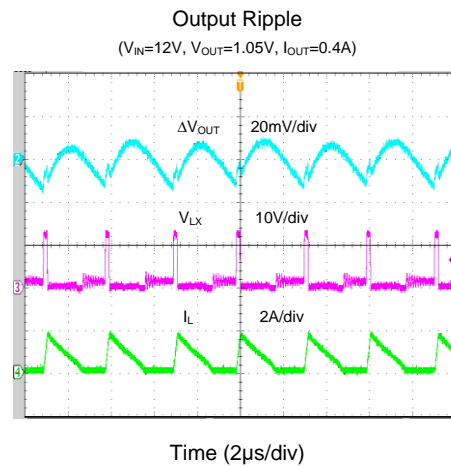
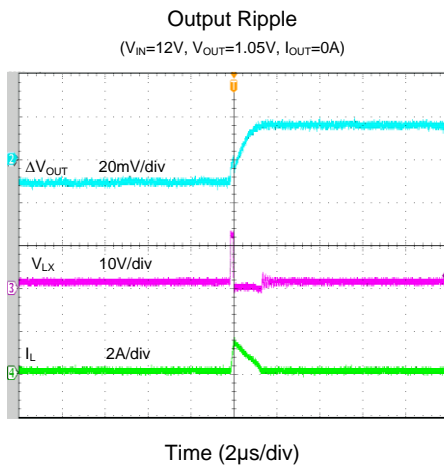
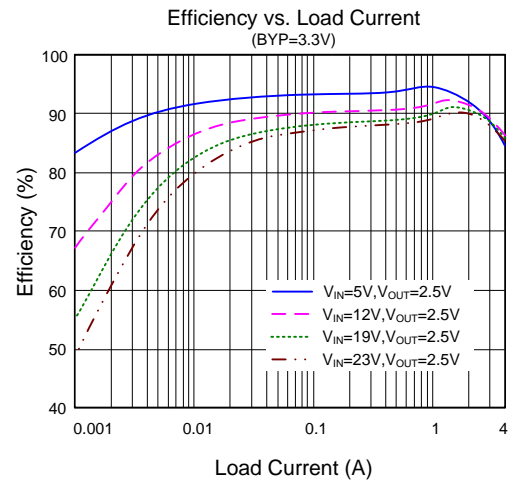
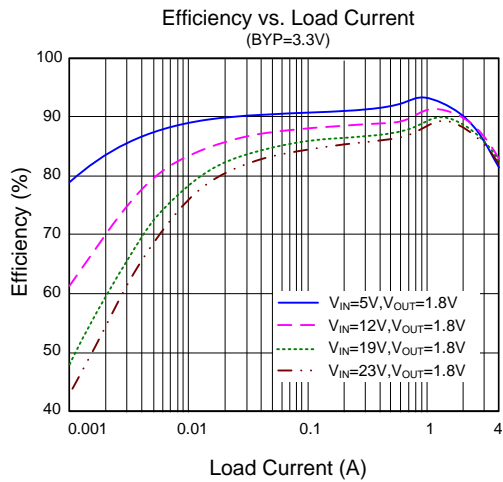
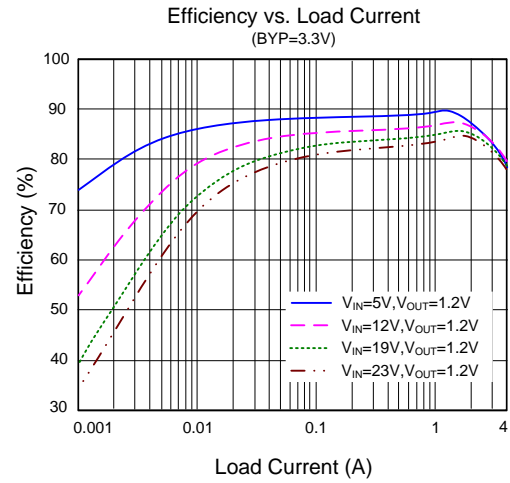
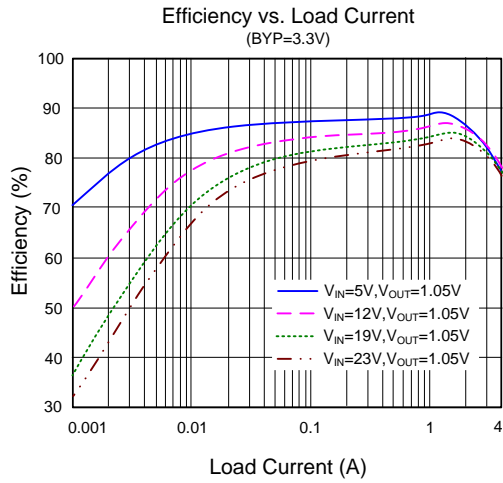

Output Ripple

($V_{IN}=12V$, $V_{OUT}=1.05V$, $I_{OUT}=2A$)

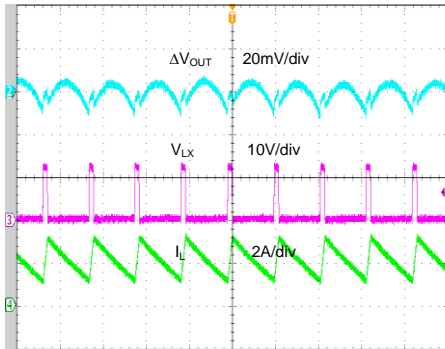

Time (2µs/div)

Output Ripple

($V_{IN}=12V$, $V_{OUT}=1.05V$, $I_{OUT}=4A$)

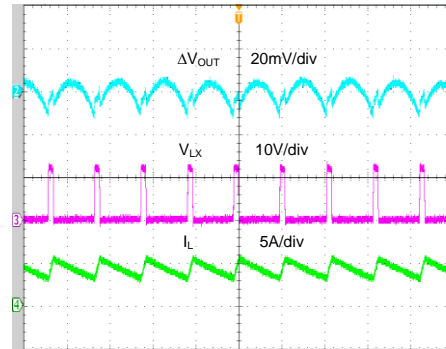

Time (2µs/div)

Startup from V_{IN}

($V_{IN}=12V$, $V_{OUT}=1.05V$, $I_{OUT}=0A$)

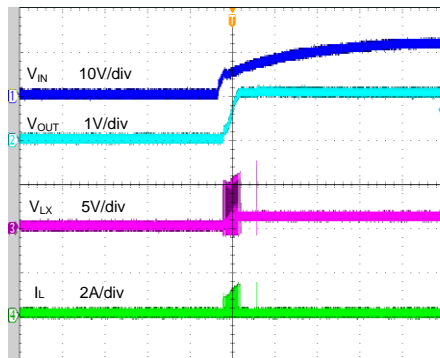

Time (2ms/div)

Shutdown from V_{IN}

($V_{IN}=12V$, $V_{OUT}=1.05V$, $I_{OUT}=0A$)

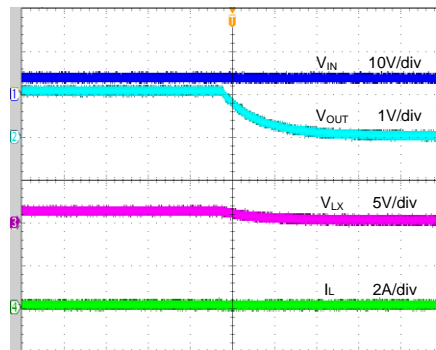

Time (2ms/div)

Startup from V_{IN}

($V_{IN}=12V$, $V_{OUT}=1.05V$, $I_{OUT}=4A$)

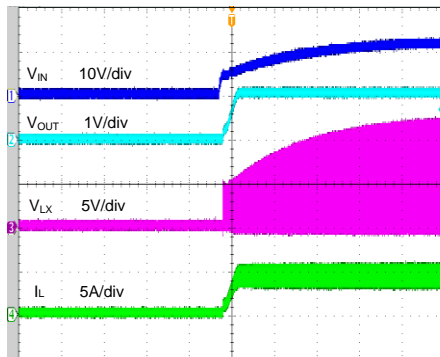

Time (2ms/div)

Shutdown from V_{IN}

($V_{IN}=12V$, $V_{OUT}=1.05V$, $I_{OUT}=4A$)

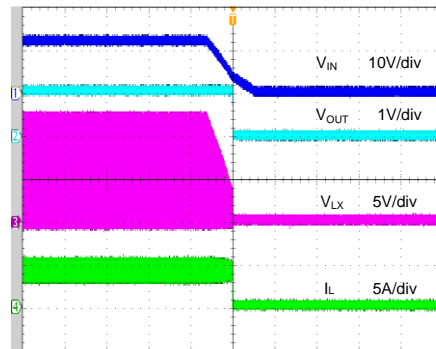

Time (2ms/div)

Startup from EN

($V_{IN}=12V$, $V_{OUT}=1.05V$, $I_{OUT}=0A$)

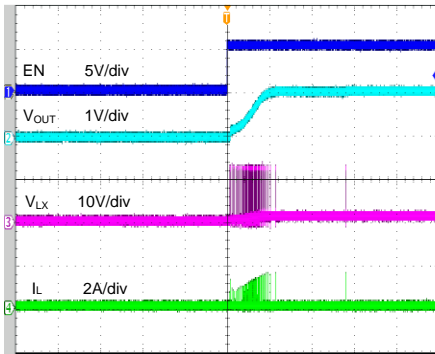

Time (800µs/div)

Shutdown from EN

($V_{IN}=12V$, $V_{OUT}=1.05V$, $I_{OUT}=0A$)

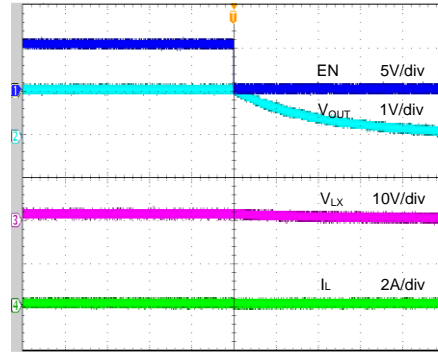

Time (800µs/div)

Startup from EN

($V_{IN}=12V$, $V_{OUT}=1.05V$, $I_{OUT}=4A$)

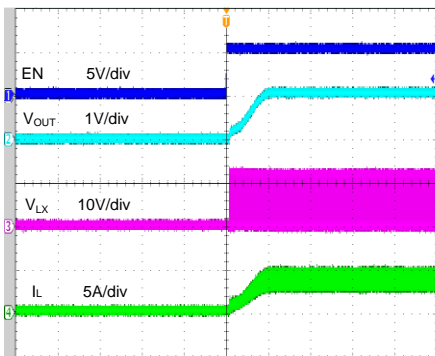

Time (800µs/div)

Shutdown from EN

($V_{IN}=12V$, $V_{OUT}=1.05V$, $I_{OUT}=4A$)

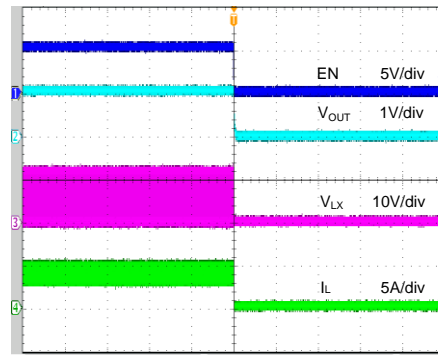

Time (800µs/div)

PG Test (V_{IN} On)

($V_{IN}=12V$, $V_{OUT}=1.05V$, $I_{OUT}=4A$)

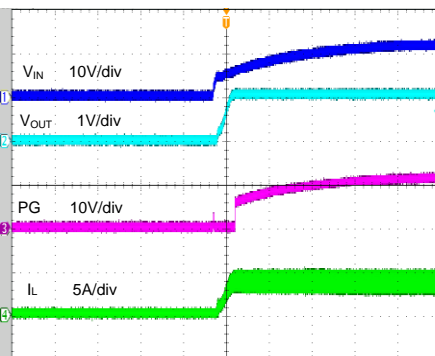

Time (2ms/div)

PG Test (V_{IN} Off)

($V_{IN}=12V$, $V_{OUT}=1.05V$, $I_{OUT}=4A$)

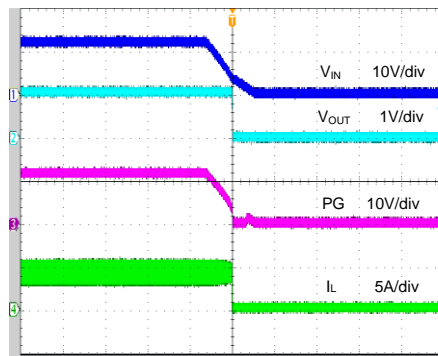

Time (2ms/div)

PG Test (EN On)
 ($V_{IN}=12V$, $V_{OUT}=1.05V$, $I_{OUT}=4A$)

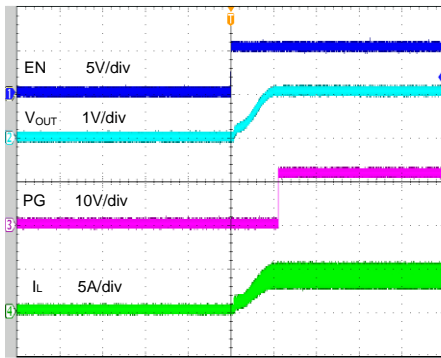

Time (800 μ s/div)

PG Test (EN Off)
 ($V_{IN}=12V$, $V_{OUT}=1.05V$, $I_{OUT}=4A$)

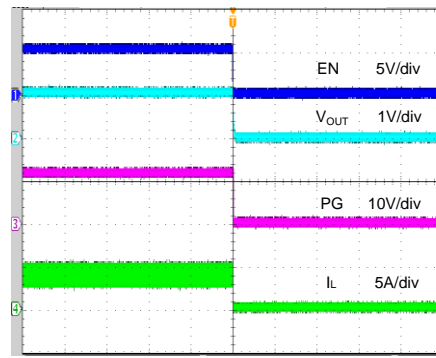

Time (800 μ s/div)

Short Circuit Protection

($V_{IN}=12V$, $V_{OUT}=1.05V$, $I_{OUT}=0A$ ~ short, $ILMT=Low$)

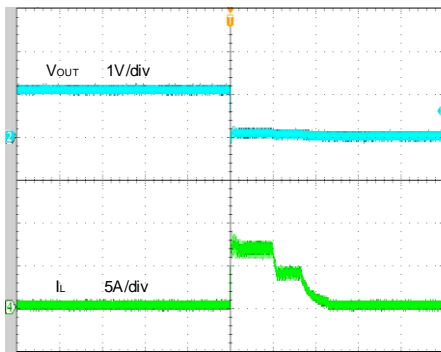

Time (100 μ s/div)

Short Circuit Protection

($V_{IN}=12V$, $V_{OUT}=1.05V$, $I_{OUT}=4A$ ~ short, $ILMT=Low$)

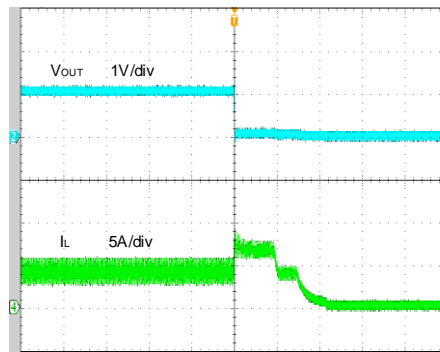

Time (100 μ s/div)

Short Circuit Protection

($V_{IN}=12V$, $V_{OUT}=1.05V$, $I_{OUT}=0A$ ~ short, $ILMT=Floating$)

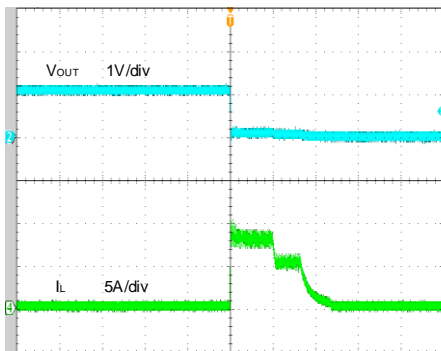

Time (100 μ s/div)

Short Circuit Protection

($V_{IN}=12V$, $V_{OUT}=1.05V$, $I_{OUT}=4A$ ~ short, $ILMT=Floating$)

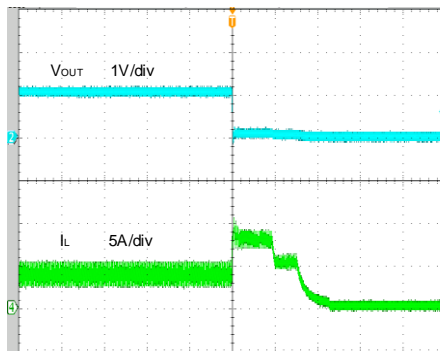

Time (100 μ s/div)

Short Circuit Protection

($V_{IN}=12V$, $V_{OUT}=1.05V$, $I_{OUT}=0A \sim \text{short}$, $ILMT=High$)

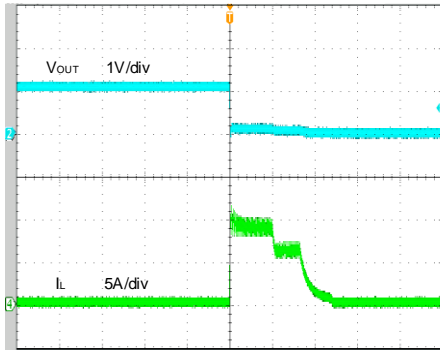

Time (100 μ s/div)

Short Circuit Protection

($V_{IN}=12V$, $V_{OUT}=1.05V$, $I_{OUT}=4A \sim \text{short}$, $ILMT=High$)

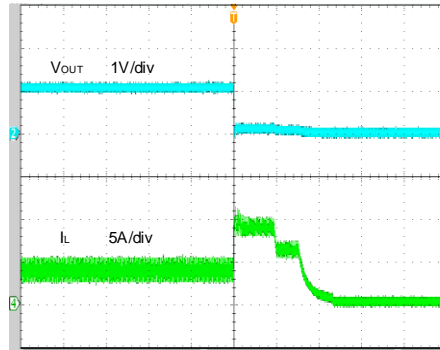

Time (100 μ s/div)

Load Transient

($V_{IN}=12V$, $V_{OUT}=1.05V$, $I_{OUT}=0 \sim 2A$)

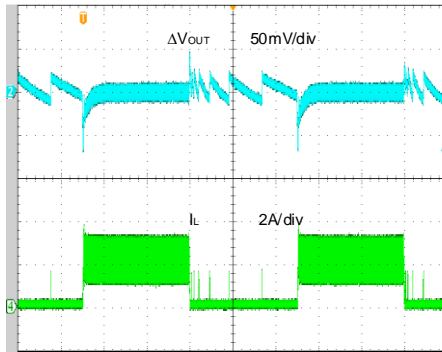

Time (200 μ s/div)

Load Transient

($V_{IN}=12V$, $V_{OUT}=1.05V$, $I_{OUT}=0.4 \sim 4A$)

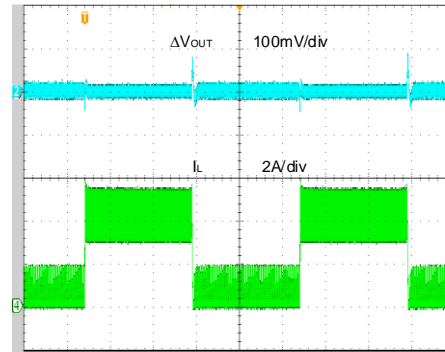

Time (200 μ s/div)

Detailed Description

General Features

Constant-on-time Architecture

Fundamental to any constant-on-time (COT) architecture is the one-shot circuit or on-time generator, which determines how long to turn on the high-side power switch. Each on-time (t_{ON}) is a “fixed” period internally calculated to operate the step down regulator at the desired switching frequency considering the input and output voltage ratio, $t_{ON}=(V_{OUT}/V_{IN})\times(1/f_{SW})$. For example, considering that a hypothetical converter targets 1.2V output from a 12V input at 500kHz, the target on-time is $(1.2V/12V)\times(1/500kHz) = 0.2\mu s$. Each t_{ON} pulse is triggered by the feedback comparator when the output voltage as measured at FB drops below the target value. After one t_{ON} period, a minimum off-time ($t_{OFF,MIN}$) is imposed before any further switching is initiated, even if the output voltage is less than the target. This approach avoids the making any switching decisions during the noisy periods just after switching events and while the switching node (LX) is rapidly rising or falling.

In a COT architecture, there is no fixed clock, so the high-side power switch can turn on almost immediately after a load transient and subsequent switching pulses can be quickly initiated, ramping the inductor current up to meet load requirements with minimal delays. Traditional current mode or voltage mode control methods must simultaneously monitor the feedback voltage, current feedback and internal ramps and compensation signals to determine when to turn off the high-side power switch and turn on the low-side synchronous rectifier. Considering these small signals in a switching environment are difficult to be noise-free after switching large currents, making those architectures difficult to apply in noisy environments and at low duty cycles.

Instant-PWM Operation

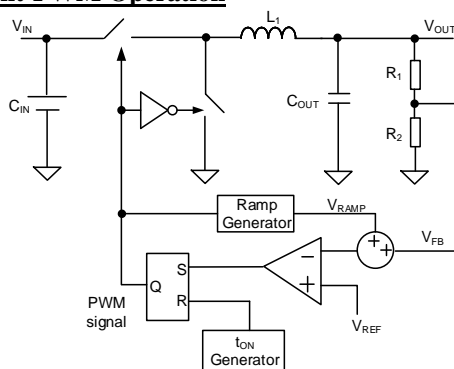

Silergy’s instant-PWM control method adds several proprietary improvements to the traditional COT architecture. Whereas most legacy based on COT

implementations require a dedicated connection to the output voltage terminal to calculate the t_{ON} duration, instant-PWM control method derives this signal internally. Another improvement optimizes operation with low ESR ceramic output capacitors. In many applications it is desirable to utilize very low ESR ceramic output capacitors, but legacy COT regulators may become unstable in these cases because the beneficial ramp signal that results from the inductor current flowing into the output capacitor maybe become too small to maintain smooth operation. For this reason, instant-PWM synthesizes a virtual replica of this signal internally. This internal virtual ramp and the feedback voltage are combined and compared to the reference voltage. When the sum is lower than the reference voltage, the t_{ON} pulse is triggered as long as the minimum t_{OFF} has been satisfied and the inductor current as measured in the low-side synchronous rectifier is lower than the bottom FET current limit. As the t_{ON} pulse is triggered, the low-side synchronous rectifier turns off and the high-side power switch turns on. Then the inductor current ramps up linearly during the t_{ON} period. At the conclusion of the t_{ON} period, the high-side power switch turns off, the low-side synchronous rectifier turns on and the inductor current ramps down linearly. This action also initiates the minimum t_{OFF} timer to ensure sufficient time for stabilizing any transient conditions and settling the feedback comparator before the next cycle is initiated. This minimum t_{OFF} is relatively short so that during high speed load transient t_{ON} can be retriggered with minimal delay, allowing the inductor current to ramp quickly to provide sufficient energy to the load side.

In order to avoid shoot-through, a dead time (t_{DEAD}) is generated internally between the high-side power switch off and the low-side synchronous rectifier on period or the low-side synchronous rectifier off and the high-side power switch on period.

Light Load Operation

Under light load conditions, typically $I_{OUT} < 1/2 \times \Delta I_L$, the current through the low-side synchronous rectifier will ramp to near zero before the next t_{ON} time. When this occurs, the low-side synchronous rectifier turns off, preventing recirculation current that can seriously reduce efficiency under these light load conditions. As load current is further reduced, and the combined feedback and ramp signals remain greater than the reference voltage, the instant-PWM control loop will not trigger another t_{ON} until needed, so the apparent operating switching frequency will correspondingly drop, further enhancing efficiency. Continuous conduction mode (CCM) resumes smoothly as soon as the load current increases sufficiently for the

inductor current to remain above zero at the time of the next t_{ON} cycle. The device enters CCM once the load current exceeds the critical level. After that, the switching frequency stays fairly constant over the output current range. The critical level of the load current is determined with

$$I_{OUT_CTL} = \frac{\Delta I_L}{2} = \frac{V_{OUT} \times (1-D)}{2 \times f_{SW} \times L_1}$$

Input Under Voltage Lock-out

To prevent operation before all internal circuitry is ready and to ensure that the power and synchronous rectifier switches can be sufficiently enhanced, instant-PWM incorporates input under voltage lock-out (UVLO) protection. The device remains in a low current state and all switching actions are inhibited until V_{IN} exceeds V_{UVLO} , the input UVLO (rising) threshold. At that time, if EN is enabled, the device will start-up by initiating a soft-start ramp. If V_{IN} falls below V_{UVLO} less than the input UVLO hysteresis, V_{HYS} , switching actions will again be suppressed.

If the input UVLO threshold is low for some high input UVLO threshold requirement applications, use EN to adjust the input UVLO by adopting two external divided resistors.

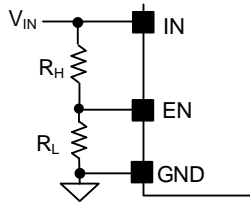

Enable Control

The EN input is a high-voltage capable input with logic-compatible threshold. When EN is driven above 1.2V (Typ) normal device operation will be enabled. When driven < 0.8V (Typ) the device will be shut down, reducing input current to < 10μA.

It is not recommended to connect EN and IN directly. A resistor in a range of 1kohm to 1Mohm should be used if EN is pulled high by IN.

Startup and Shutdown

The SY8284 incorporates an internal soft-start circuit to smoothly ramp the output to the desired voltage whenever the device enabled. Internally, the soft-start circuit clamps the output at a low voltage and then allows the output to rise to the desired voltage over approximately 600μs, which avoids high current flow and transients during startup. The startup and shutdown sequence are shown below.

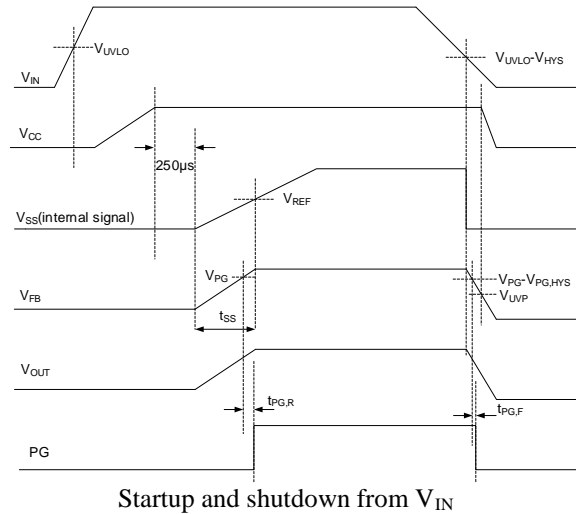

Startup and shutdown from V_{IN}

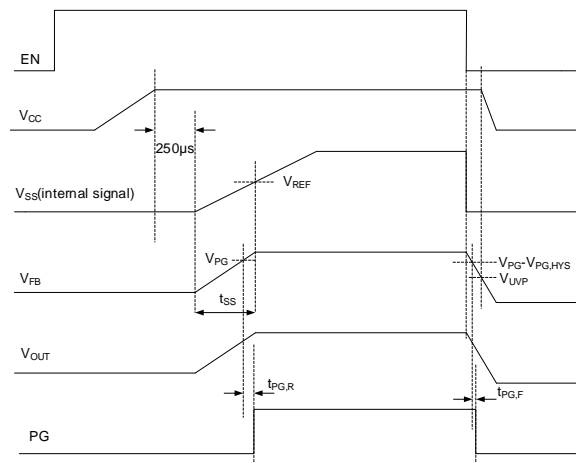

Startup and shutdown from EN

Output Discharge

SY8284 discharges the output voltage when the converter shuts down from V_{IN} or EN, or thermal shutdown, so that output voltage can be discharged in a minimal time, even load current is zero. The discharge FET in parallel with the low-side synchronous rectifier turns on after the low-side synchronous rectifier turns off when shut down logic is triggered. The output discharge current is typically 50mA. Note that the discharge FET is not active beyond these shutdown conditions.

Power Good Indicator

The power good indicator is an open drain output controlled by a window comparator connected to the feedback signal. If V_{FB} is greater than V_{PG} and less than V_{OVP} for at least the power good delay time, PG will be high-impedance.

External Bootstrap Capacitor Connection

This device integrates a floating power supply for the gate driver that operates the high-side power switch. Proper operation requires a 0.1μF low ESR ceramic capacitor to be connected between BS and LX. This bootstrap capacitor provides the gate driver supply voltage for the high-side N-channel MOSFET power switch.

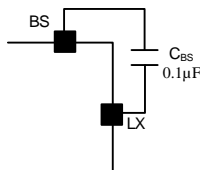

VCC Linear Regulator

An internal linear regulator (VCC) produces a 3.3V supply from V_{IN} that powers the internal gate drivers, PWM logic, analog circuitry, and other blocks. Connect a 2.2μF low ESR ceramic capacitor from VCC to GND.

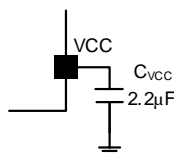

BYP Input

The control and drive circuit can also be powered by external 3.3V power supply. When a 3.3V external power supply is connected to the BYP pin, the VCC LDO is turned off and the switch between BYP and VCC is turned on. The overall efficiency may be improved by connecting the BYP pin to external 3.3V switching power supply. Connect a 1.0μF low ESR ceramic capacitor from BYP pin to GND when BYP is supplied by 3.3V external power. Leave BYP pin floating if this feature is not used.

Fault Protection Modes

Current Limit

Instant-PWM incorporates a cycle-by-cycle “valley” current limit (bottom FET current limit). Inductor current is measured in the low-side synchronous rectifier when it turns on. If the current exceeds the bottom FET current limit, t_{ON} is inhibited until the current returns back to safe levels. The bottom FET current default limit value can change from a high level to a low level if V_{OUT} < ~60% of the set point for approximately 125μs. Bottom FET current limit can be selectable by pulling ILMT pin low, high or leaves it floating.

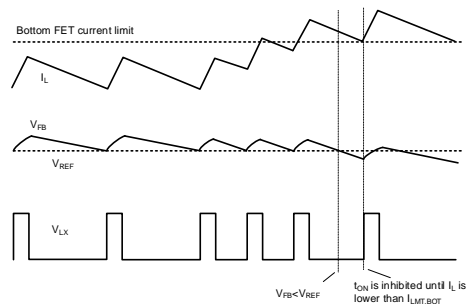

The device also features cycle-by-cycle “peak” current limit (top FET current limit). During t_{ON} time, the high-side power switch current is monitored. If the monitored current exceeds the top FET current limit, the high-side power switch is turned off, the low-side synchronous rectifier is turned on and then t_{ON} is inhibited. t_{ON} can be not inhibited any more once low-side synchronous rectifier current is lower than the bottom FET current limit value.

Output Under Voltage Protection (UVP)

If V_{OUT} < ~60% of the set point for approximately 250μs occurring when the output short circuit or the load current is heavier than the maximum current capacity, the output under voltage protection (UVP) will be triggered, and the device will latch off. Recycling EN input to re-enable the device.

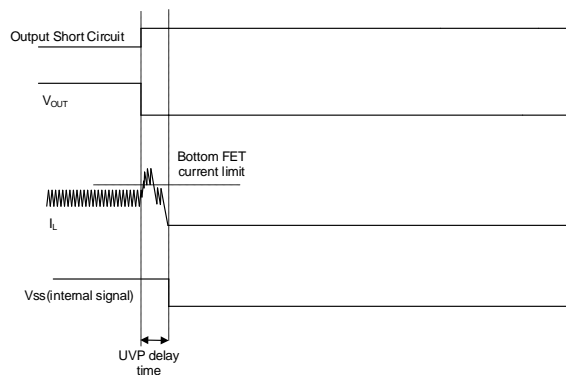

Output Over Voltage Protection (OVP)

This device includes output over voltage protection (OVP). If the output voltage rises above the feedback regulation level, the high-side power switch naturally remains off. If the output voltage remains high, the low-side synchronous rectifier remains on until the inductor current reaches zero and the switching actions are suppressed. The switching actions will be recovered once the combined feedback and ramp signals become lower than the reference voltage. If the output voltage continues to rise and exceeds the output over voltage threshold for more than OVP delay time, output over voltage protection(OVP) will

be triggered, and the device will latch off. Recycling EN input to re-enable the device.

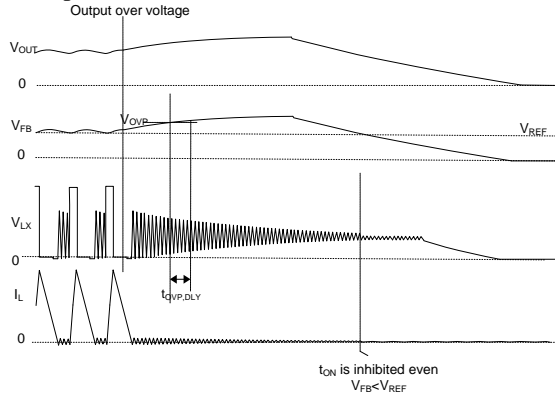

Over Temperature Protection (OTP)

Instant-PWM includes over temperature protection (OTP) circuitry to prevent overheating due to excessive power dissipation. This will shut down the device and the device will latch off. Recycling EN input to re-enable the device. For continuous operation, provide adequate cooling so that the junction temperature does not exceed the OTP threshold.

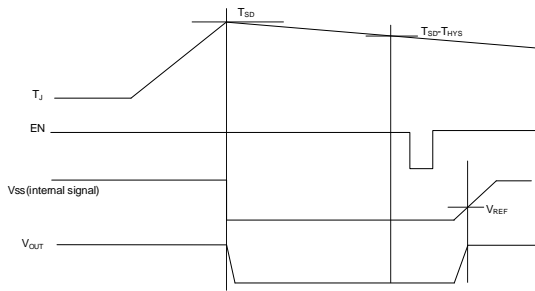

Design Procedure

Feedback Resistor Selection

Choose R_1 and R_2 to program the proper output voltage. To minimize the power consumption under light loads, it is desirable to choose large resistance values for both R_1 and R_2 . A value of between 10k Ω and 1M Ω is strongly recommended for both resistors. If V_{SET} is 1.2V, $R_1=100k\Omega$ is chosen, then using following equation, R_2 can be calculated to be 100k Ω .

$$R_2 = \frac{0.6V}{V_{SET} - 0.6V} \times R_1$$

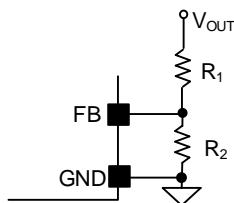

Inductor Selection

The inductor is necessary to supply constant current to the output load while being driven by the switched input voltage.

Instant-PWM operates well over a wide range of inductor values. This flexibility allows for optimization to find the best trade-off of efficiency, cost and size for a particular application. Selecting a low inductor value will help reduce size and cost and enhance transient response, but will increase peak inductor ripple current, reducing efficiency and increasing output voltage ripple. The low DC resistance (DCR) of these low value inductors may help reduce DC losses and increase efficiency. On the other hand, higher inductor values tend to have higher DCR and will slow transient response.

A reasonable compromise between size, efficiency, and transient response can be determined by selecting a ripple current (ΔI_L) about 20~50% of the desired full output load current. Start by calculating the approximate inductor value by selecting the input and output voltages, the operating frequency (f_{SW}), the maximum output current ($I_{OUT,MAX}$) and estimating a ΔI_L as some percentage of that current.

$$L_1 = \frac{V_{OUT} \times (V_{IN} - V_{OUT})}{V_{IN} \times f_{SW} \times \Delta I_L}$$

Use this inductance value to determine the actual inductor ripple current (ΔI_L) and required peak current inductor current $I_{L,PEAK}$.

$$\Delta I_L = \frac{V_{OUT} \times (V_{IN} - V_{OUT})}{V_{IN} \times f_{SW} \times L_1}$$

$$\text{And } I_{L,PEAK} = I_{OUT,MAX} + \Delta I_L / 2$$

Select an inductor with a saturation current and thermal rating in excess of $I_{L,PEAK}$.

For highest efficiency, select an inductor with a low DCR that meets the inductance, size and cost targets. Low loss ferrite materials should be considered.

Inductor Design Example

Consider a typical design for a device providing 1.2V $_{OUT}$ at 4A from 12V $_{IN}$, operating at 500kHz and using target inductor ripple current (ΔI_L) of 40% or 1.6A. Determine the approximate inductance value at first:

$$L_1 = \frac{1.2V \times (12V - 1.2V)}{12V \times 500kHz \times 1.6A} = 1.35\mu H$$

Next, select the nearest standard inductance value, in this case 1.5 μH , and calculate the resulting inductor ripple current (ΔI_L):

$$\Delta I_L = \frac{1.2V \times (12V - 1.2V)}{12V \times 500kHz \times 1.5\mu H} = 1.44A$$

$$I_{L,PEAK} = 4A + 1.44A/2 = 4.72A$$

The resulting 1.44A ripple current is 1.44A/4A is ~36%, well within the 20%~50% target.

Finally, select an available inductor with a saturation current higher than the resulting $I_{L,PEAK}$ of 4.72A.

Input Capacitor Selection

Input filter capacitors are needed to reduce the ripple voltage on the input, to filter the switched current drawn from the input supply and to reduce potential EMI. When selecting an input capacitor, be sure to select a voltage rating at least 20% greater than the maximum voltage of the input supply and a temperature rating above the system requirements. X5R series ceramic capacitors are most often selected due to their small size, low cost, surge current capability and high RMS current ratings over a wide temperature and voltage range. However, systems that are powered by a wall adapter or other long and therefore inductive cabling may be susceptible to significant inductive ringing at the input to the device. In these cases, consider adding some bulk capacitance like electrolytic, tantalum or polymer type capacitors. Using a combination of bulk capacitors (to reduce overshoot or ringing) in parallel with ceramic capacitors (to meet the RMS current requirements) is helpful in these cases.

Consider the RMS current rating of the input capacitor, paralleling additional capacitors if required to meet the calculated RMS ripple current,

$$I_{CIN,RMS} = I_{OUT} \times \sqrt{D \times (1-D)}$$

The worst-case condition occurs at $D=0.5$, then

$$I_{CIN,RMS,MAX} = \frac{I_{OUT}}{2}$$

For simplification, choose an input capacitor with an RMS current rating greater than half of the maximum load current.

On the other hand, the input capacitor value determines the input voltage ripple of the converter. If there is an input voltage ripple requirement in the system, choose an appropriate input capacitor that meets the specification.

Given the very low ESR and ESL of ceramic capacitors, the input voltage ripple can be estimated by

$$V_{CIN,RIPPLE,CAP} = \frac{I_{OUT}}{f_{SW} \times C_{IN}} \times D \times (1-D)$$

The worst-case condition occurs at $D=0.5$, then

$$V_{CIN,RIPPLE,CAP,MAX} = \frac{I_{OUT}}{4 \times f_{SW} \times C_{IN}}$$

The capacitance value is less important than the RMS current rating. In most applications a single 10 μ F X5R capacitor is sufficient. Take care to locate the ceramic input capacitor as close to the device IN and GND pin as possible.

Output Capacitor Selection

Instant-PWM provides excellent performance with a wide variety of output capacitor types. Ceramic and POS types are most often selected due to their small size and low cost. Total capacitance is determined by the transient response and output voltage ripple requirements of the system.

Output Ripple

Output voltage ripple at the switching frequency is caused by the inductor current ripple (ΔI_L) on the output capacitors ESR (ESR ripple) as well as the stored charge (capacitive ripple). When considering total ripple, both should be considered.

$$V_{RIPPLE,ESR} = \Delta I_L \times ESR$$

$$V_{RIPPLE,CAP} = \frac{\Delta I_L}{8 \times C_{OUT} \times f_{SW}}$$

Consider a typical application with $\Delta I_L=1.44A$ using two 22 μ F ceramic capacitors, each with an ESR of ~6m Ω for parallel total of 44 μ F and 3m Ω ESR.

$$V_{RIPPLE,ESR} = 1.44A \times 3m\Omega = 4.32mV$$

$$V_{RIPPLE,CAP} = \frac{1.44A}{8 \times 44\mu F \times 500kHz} = 8.18mV$$

Total ripple = 12.5mV. The actual capacitive ripple may be higher than calculated value because the capacitance decreases with the voltage on the capacitor.

Using a 150 μ F 40m Ω POS cap, the above result is

$$V_{RIPPLE,ESR} = 1.44A \times 40m\Omega = 57.60mV$$

$$V_{RIPPLE,CAP} = \frac{1.44A}{8 \times 150\mu F \times 500kHz} = 2.40mV$$

Total ripple = 60.0mV

Output Transient Undershoot/Overshoot

If very fast load transient must be supported, consider the effect of the output capacitor on the output transient undershoot and overshoot. Instant-PWM responds quickly to changing load conditions, however, some considerations must be needed, especially when using small ceramic capacitors which have low capacitance at low output voltages which results in insufficient stored energy for load transient. Output transient undershoot and overshoot

have two causes: voltage changes caused by the ESR of the output capacitor and voltage changes caused by the output capacitance and inductor current slew rate.

ESR undershoot or overshoot may be calculated as $V_{ESR} = \Delta I_{OUT} \times ESR$. Using the ceramic capacitor example above and a fast load transient of $\pm 2A$, $V_{ESR} = \pm 2A \times 3m\Omega = \pm 6mV$. The POS capacitor result with the same load transient, $V_{ESR} = \pm 2A \times 40m\Omega = \pm 80mV$.

Capacitive undershoot (load increasing) is a function of the output capacitance, the load step, the inductor value and the input-output voltage difference and the maximum duty factor. During a fast load transient, the maximum duty factor of instant-PWM is a function of t_{ON} and the minimum t_{OFF} as the control scheme is designed to rapidly ramp the inductor current by grouping together many t_{ON} pulses in this case. The maximum duty factor D_{MAX} may be calculated by

$$D_{MAX} = \frac{t_{ON}}{t_{ON} + t_{OFF,MIN}}$$

Given this, the capacitive undershoot may be calculated by

$$V_{UNDERSHOOT,CAP} = -\frac{L_1 \times \Delta I_{OUT}^2}{2 \times C_{OUT} \times (V_{IN,MIN} \times D_{MAX} - V_{OUT})}$$

Consider a 2A load increase using the ceramic capacitor case when $V_{IN} = 12V$. At $V_{OUT} = 1.2V$, the result is $t_{ON} = 200ns$, $t_{OFF,MIN} = 150ns$, $D_{MAX} = 200/(200+150) = 0.57$ and

$$V_{UNDERSHOOT,CAP} = -\frac{1.5\mu H \times (2A)^2}{2 \times 44\mu F \times (12V \times 0.57 - 1.2V)} = -12.1mV$$

Using the POS capacitor case, the above result is

$$V_{UNDERSHOOT,CAP} = -\frac{1.5\mu H \times (2A)^2}{2 \times 150\mu F \times (12V \times 0.57 - 1.2V)} = -3.5mV$$

Capacitive overshoot (load decreasing) is a function of the output capacitance, the inductor value and the output voltage.

$$V_{OVERSHOOT,CAP} = \frac{L_1 \times \Delta I_{OUT}^2}{2 \times C_{OUT} \times V_{OUT}}$$

Consider a 2A load decrease using the ceramic capacitor case above. At $V_{OUT} = 1.2V$ the result is

$$V_{OVERSHOOT,CAP} = \frac{1.5\mu H \times (2A)^2}{2 \times 44\mu F \times 1.2V} = 56.8mV$$

Using the POS capacitor case, the above result is

$$V_{OVERSHOOT,CAP} = \frac{1.5\mu H \times (2A)^2}{2 \times 150\mu F \times 1.2V} = 16.7mV$$

Combine the ESR and capacitive undershoot and overshoot to calculate the total overshoot and undershoot for a given application.

Feed-forward Compensation (R_{FF} , C_{FF})

The SY8284 is internally compensated and optimized for low duty cycle applications. However, in some applications, especially where $V_{OUT} > 1.2V$, the feedback divider attenuates the AC component of the output. In these cases, transient response may be improved by adding feed-forward compensation. $R_{FF} = 1k\Omega$ and $C_{FF} = 220pF$ have been shown to perform well in most applications.

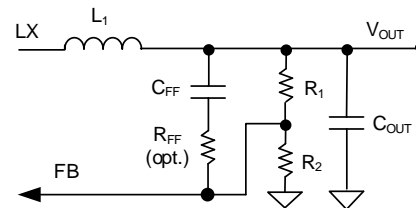

Note that when $C_{OUT} > 500\mu F$ and minimum load current is low, set feed-forward values as $R_{FF} = 1k\Omega$ and $C_{FF} = 10nF$ to provide sufficient ripple to FB for small output ripple and good transient behavior.

Thermal Design Considerations

Maximum power dissipation depends on the thermal resistance of the IC package, the PCB layout, the surrounding airflow, and the difference between the junction and ambient temperatures. The maximum power dissipation may be calculated by:

$$P_{D,MAX} = (T_{J,MAX} - T_A) / \theta_{JA}$$

Where, $T_{J,MAX}$ is the maximum junction temperature, T_A is the ambient temperature, and θ_{JA} is the junction to ambient thermal resistance.

To comply with the recommended operating conditions, the maximum junction temperature is 125°C. The junction to ambient thermal resistance θ_{JA} is layout dependent. For the QFN3x3-20 package the thermal resistance θ_{JA} is 30°C/W when measured on a standard Silergy four-layer thermal test board. These standard thermal test layouts have a very large area with long 2oz. copper traces connected to each IC pin and very large, unbroken 1oz. internal power and ground planes.

Meeting the performance of the standard thermal test board in a typical tiny evaluation board area requires wide copper traces well-connected to the IC's backside pads leading to exposed copper areas on the component side of the board as well as good thermal via from the exposed pad connecting to a wide middle-layer ground plane and, perhaps, to an exposed copper area on the board's solder side.

The maximum power dissipation at $T_A = 25^\circ C$ may be calculated by the following formula:

$$P_{D,MAX} = (125^\circ C - 25^\circ C) / (30^\circ C/W) = 3.33W$$

The maximum power dissipation depends on operating ambient temperature for fixed $T_{J,MAX}$ and thermal resistance θ_{JA} . Use the derating curve in figure below to calculate the effect of rising ambient temperature on the maximum power dissipation.

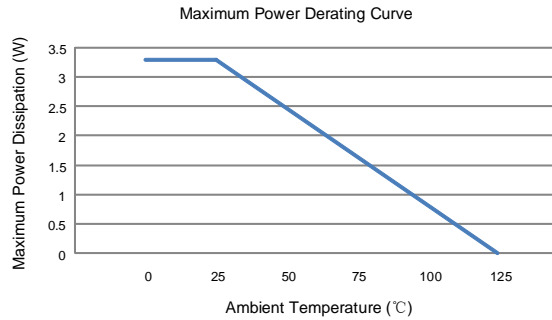

Layout Design

Follow these PCB layout guidelines for optimal performance.

- Keep the high current traces as short and wide as possible.
- Place the input capacitor very near IN and GND, minimizing the loop formed by these connections.
- Place the VCC capacitor close to VCC using short, direct connections to the device GND connection.

- Place the FB components (R_1 , R_2 , R_{FF} and C_{FF}) as close to FB as possible. Avoid routing the FB trace near LX as it is noise sensitive.
- Make the feedback sampling point connect with C_{OUT} rather than the inductor output terminal.
- The LX connection has large voltage swings and fast edges and can easily radiate noise to adjacent components. Keep its area small to prevent excessive EMI, while providing wide copper traces to minimize parasitic resistance and inductance. Keep sensitive components away from the switching node or provide ground traces between for shielding, to prevent stray capacitive noise pickup.
- The exposed GND pad should be connected to a large copper area for heat sinking and to minimize noise.
- Provide dedicated wide copper traces for the power path ground between the IC and the input and output capacitor grounds, rather than connecting each of these individually to an internal ground plane.
- Avoid using vias in the power path connections that have switched currents (from C_{IN} to GND and C_{IN} to V_{IN}) and the switching node (LX).

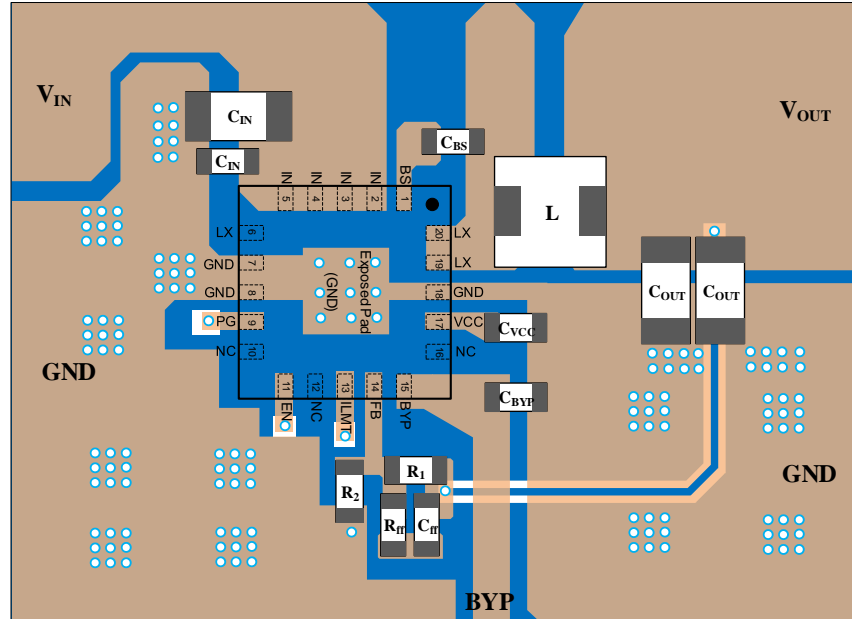
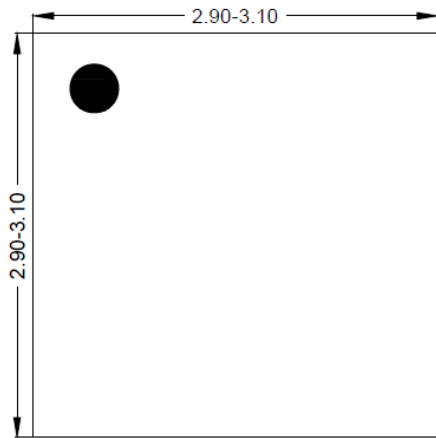
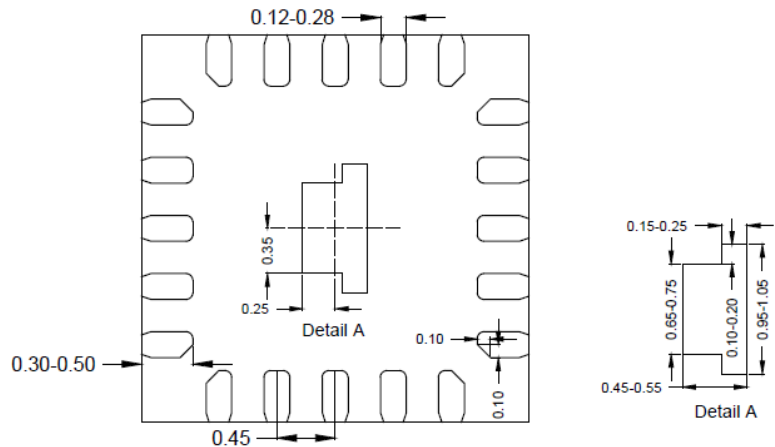

Figure4. PCB Layout Suggestion

QFN3×3-20 Package Outline



Top view



Bottom view

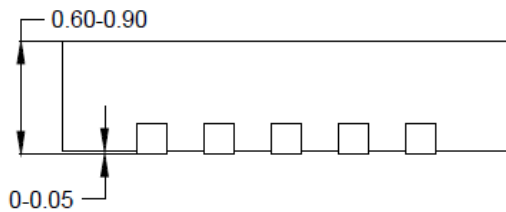

Side view

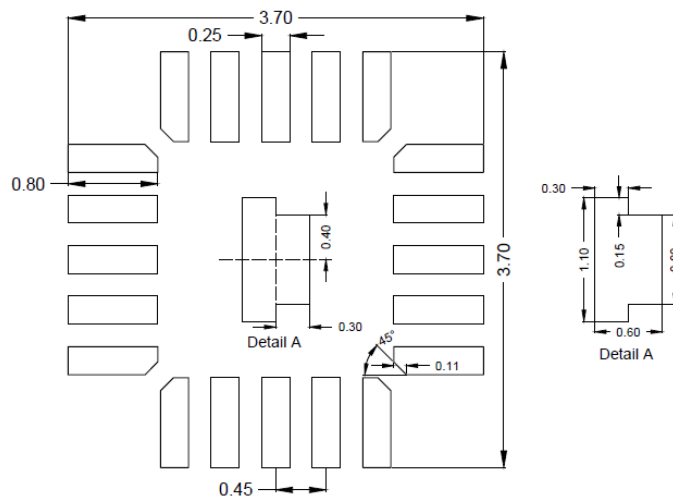

**Recommended PCB layout
(Reference only)**

Notes: All dimension in millimeter and exclude mold flash & metal burr.

Taping & Reel Specification

1. QFN3×3-20 taping orientation

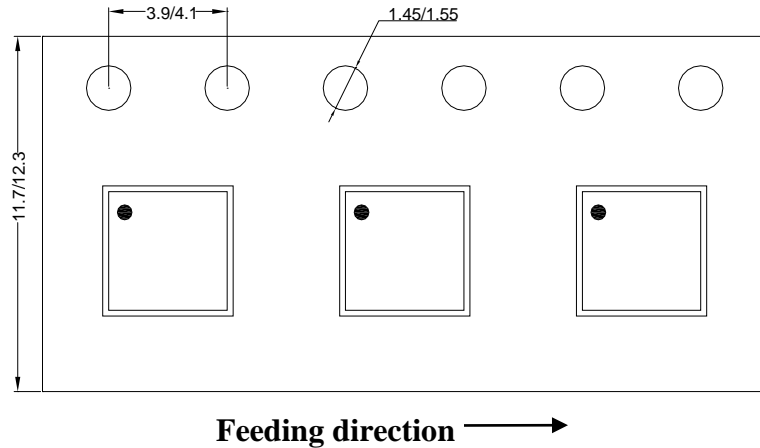

2. Carrier Tape & Reel specification for packages

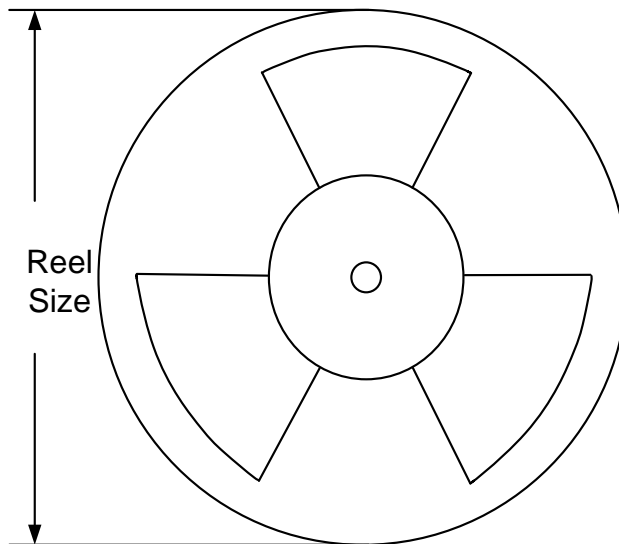

Package type	Tape width (mm)	Pocket pitch(mm)	Reel size (Inch)	Trailer length(mm)	Leader length (mm)	Qty per reel
QFN3×3	12	8	13"	400	400	5000

3. Others: NA

**IMPORTANT NOTICE**

1. **Right to make changes.** Silergy and its subsidiaries (hereafter Silergy) reserve the right to change any information published in this document, including but not limited to circuitry, specification and/or product design, manufacturing or descriptions, at any time and without notice. This document supersedes and replaces all information supplied prior to the publication hereof. Buyers should obtain the latest relevant information before placing orders and should verify that such information is current and complete. All semiconductor products are sold subject to Silergy's standard terms and conditions of sale.
2. **Applications.** Application examples that are described herein for any of these products are for illustrative purposes only. Silergy makes no representation or warranty that such applications will be suitable for the specified use without further testing or modification. Buyers are responsible for the design and operation of their applications and products using Silergy products. Silergy or its subsidiaries assume no liability for any application assistance or designs of customer products. It is customer's sole responsibility to determine whether the Silergy product is suitable and fit for the customer's applications and products planned. To minimize the risks associated with customer's products and applications, customer should provide adequate design and operating safeguards. Customer represents and agrees that it has all the necessary expertise to create and implement safeguards which anticipate dangerous consequences of failures, monitor failures and their consequences, lessen the likelihood of failures that might cause harm and take appropriate remedial actions. Silergy assumes no liability related to any default, damage, costs or problem in the customer's applications or products, or the application or use by customer's third-party buyers. Customer will fully indemnify Silergy, its subsidiaries, and their representatives against any damages arising out of the use of any Silergy components in safety-critical applications. It is also buyers' sole responsibility to warrant and guarantee that any intellectual property rights of a third party are not infringed upon when integrating Silergy products into any application. Silergy assumes no responsibility for any said applications or for any use of any circuitry other than circuitry entirely embodied in a Silergy product.
3. **Limited warranty and liability.** Information furnished by Silergy in this document is believed to be accurate and reliable. However, Silergy makes no representation or warranty, expressed or implied, as to the accuracy or completeness of such information and shall have no liability for the consequences of use of such information. In no event shall Silergy be liable for any indirect, incidental, punitive, special or consequential damages, including but not limited to lost profits, lost savings, business interruption, costs related to the removal or replacement of any products or rework charges, whether or not such damages are based on tort or negligence, warranty, breach of contract or any other legal theory. Notwithstanding any damages that customer might incur for any reason whatsoever, Silergy' aggregate and cumulative liability towards customer for the products described herein shall be limited in accordance with the Standard Terms and Conditions of Sale of Silergy.
4. **Suitability for use.** Customer acknowledges and agrees that it is solely responsible for compliance with all legal, regulatory and safety-related requirements concerning its products, and any use of Silergy components in its applications, notwithstanding any applications-related information or support that may be provided by Silergy. Silergy products are not designed, authorized or warranted to be suitable for use in life support, life-critical or safety-critical systems or equipment, nor in applications where failure or malfunction of an Silergy product can reasonably be expected to result in personal injury, death or severe property or environmental damage. Silergy assumes no liability for inclusion and/or use of Silergy products in such equipment or applications and therefore such inclusion and/or use is at the customer's own risk.
5. **Terms and conditions of commercial sale.** Silergy products are sold subject to the standard terms and conditions of commercial sale, as published at <http://www.silergy.com/stdterms>, unless otherwise agreed in a valid written individual agreement specifically agreed to in writing by an authorized officer of Silergy. In case an individual agreement is concluded only the terms and conditions of the respective agreement shall apply. Silergy hereby expressly objects to and denies the application of any customer's general terms and conditions with regard to the purchase of Silergy products by the customer.
6. **No offer to sell or license.** Nothing in this document may be interpreted or construed as an offer to sell products that is open for acceptance or the grant, conveyance or implication of any license under any copyrights, patents or other industrial or intellectual property rights. Silergy makes no representation or warranty that any license, either express or implied, is granted under any patent right, copyright, mask work right, or other intellectual property right. Information published by Silergy regarding third-party products or services does not constitute a license to use such products or services or a warranty or endorsement thereof. Use of such information may require a license from a third party under the patents or other intellectual property of the third party, or a license from Silergy under the patents or other intellectual property of Silergy.

For more information, please visit: www.silergy.com

© 2018 Silergy Corp.

All Rights Reserved.