

### General Description

The SY8892 is a high efficiency 1.5MHz synchronous step down DC/DC regulator, capable of delivering up to 2A output currents. It can operate over a wide input voltage range from 2.5V to 5.5V and integrates main switch and synchronous switch with very low  $R_{DS(ON)}$  to minimize the conduction loss.

The SY8892 is in a space saving, low profile SOT563 package.

### Ordering Information

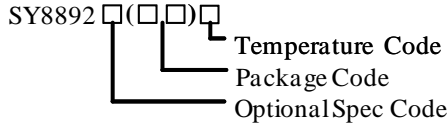

Ordering Number	Package type	Note
SY8892ARC	SOT563	--

### Features

- 2.5V to 5.5V Input Voltage Range
- 55  $\mu$ A Low Quiescent Current
- Low  $R_{DS(ON)}$  for Internal Switches (Top/Bottom): 125m $\Omega$  /75m $\Omega$
- High Switching Frequency 1.5MHz Minimizes the External Components
- Internal Soft-start Limits the Inrush Current
- 100% Dropout Operation
- Power Good Indicator
- Hic-cup for Short Circuit Protection
- Output Auto Discharge Function
- RoHS Compliant and Halogen Free
- Compact Package: SOT563

### Applications

- Set Top Box
- USB Dongle
- Media Player
- Smart Phone

### Typical Application

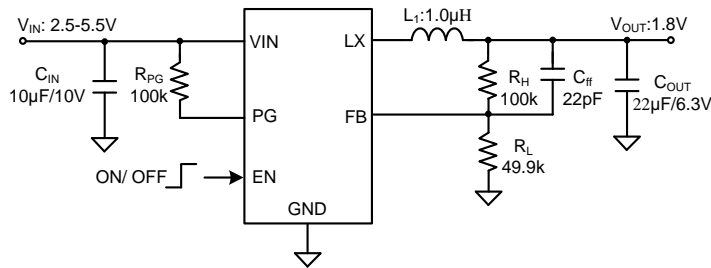

Figure1. Schematic Diagram

Inductor and  $C_{OUT}$  Selection Table

$V_{OUT}$ [V]	L [ $\mu$ H]	$C_{OUT}$ [ $\mu$ F]			
		4.7	10	22	22x2
1.2	1.0			☆	√
	1.5			√	√
	2.2			√	√
1.8/3.3	1.0		√	☆	√
	1.5		√	√	√
	2.2		√	√	√

Note: '☆' means recommended for most applications.

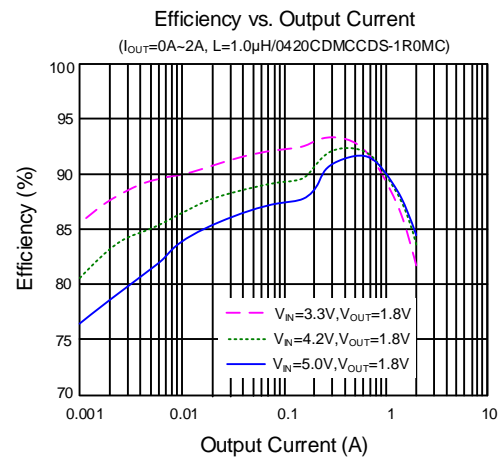
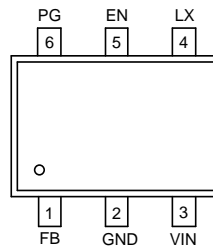

Figure2. Efficiency vs. Output Current

**Pin Out (Top View)**



**Top Mark: M4xyz** (device code: M4, x=year code, y=week code, z=lot number code)

**Pin Description**

Pin Name	Pin Number	Pin Description
FB	1	Output feedback pin. Connect this pin to the center point of the output resistor divider (as shown in Figure 1) to program the output voltage: $V_{OUT}=0.6 \times (1+R_H/R_L)$ .
GND	2	Ground pin.
VIN	3	Input pin. Decouple this pin to the GND pin with at least a 10µF ceramic capacitor.
LX	4	Inductor pin. Connect this pin to the switching node of the inductor.
EN	5	Enable control. Pull high to turn on. Do not leave it floating.
PG	6	Power good indicator. Power good indicator (open drain output). Low if the output < 90% or the output >120% of regulation voltage; High otherwise. Connect a pull-up resistor to the input.

**Function Block**

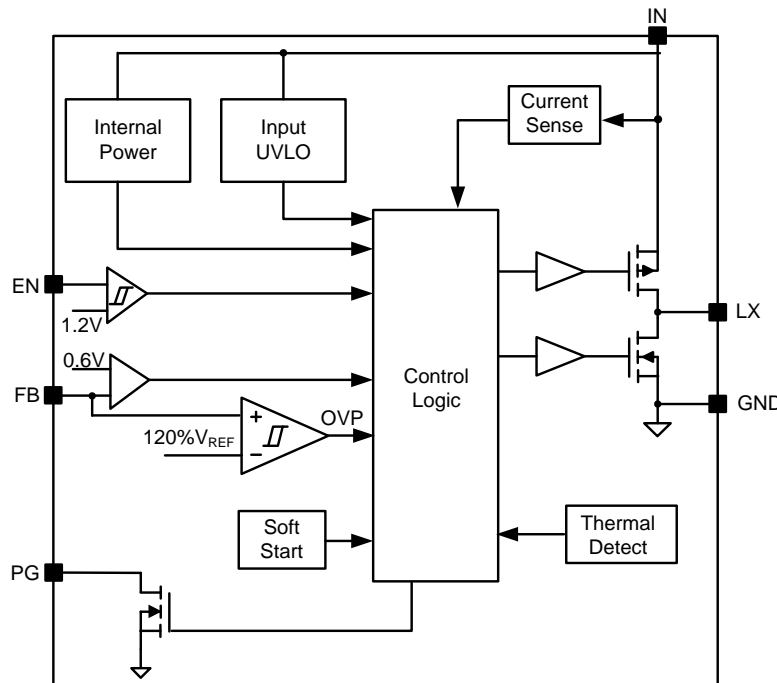

Figure3. Block Diagram



**Absolute Maximum Ratings** (Note 1)

Supply Input Voltage-----	-0.3V to 6.0V
FB, EN, PG Voltage-----	-0.3V to $V_{IN} + 0.6V$
LX Voltage-----	-0.3V <sup>(*1)</sup> to 6.0V <sup>(*2)</sup>
Power Dissipation, $P_D$ @ $T_A = 25\text{ }^\circ\text{C}$ -----	1.11W
Package Thermal Resistance (Note 2)	
$\theta_{JA}$ -----	90 $^\circ\text{C/W}$
$\theta_{JC}$ -----	20 $^\circ\text{C/W}$
Junction Temperature Range -----	-40 $^\circ\text{C}$ to 150 $^\circ\text{C}$
Lead Temperature (Soldering, 10 sec.) -----	260 $^\circ\text{C}$
Storage Temperature Range -----	-65 $^\circ\text{C}$ to 150 $^\circ\text{C}$
<sup>(*1)</sup> LX Voltage Tested Down to -3V <20ns	
<sup>(*2)</sup> LX Voltage Tested Up to +7V <20ns	

**Recommended Operating Conditions** (Note 3)

Supply Input Voltage -----	2.5V to 5.5V
Junction Temperature Range -----	-40 $^\circ\text{C}$ to 125 $^\circ\text{C}$
Ambient Temperature Range -----	-40 $^\circ\text{C}$ to 85 $^\circ\text{C}$

**Electrical Characteristics**(V<sub>IN</sub> = 5V, V<sub>OUT</sub> = 1.8V, L = 1.0μH, C<sub>OUT</sub> = 22μF, T<sub>A</sub> = 25 °C, unless otherwise specified)

Parameter	Symbol	Test Conditions	Min	Typ	Max	Unit
Input Voltage Range	V <sub>IN</sub>		2.5		5.5	V
Input UVLO Threshold	V <sub>UVLO</sub>			2.45	2.5	V
Input UVLO Hysteresis	V <sub>YST</sub>			150		mV
Shutdown Current	I <sub>SHDN</sub>	V <sub>EN</sub> =0V		0.1	1	μA
Quiescent Current	I <sub>Q</sub>	V <sub>FB</sub> =V <sub>REF</sub> ×105%		55		μA
Feedback Reference Voltage	V <sub>REF</sub>	I <sub>OUT</sub> =1A, CCM	0.591	0.6	0.609	V
LX Node Discharge Resistance	R <sub>DIS</sub>			50		Ω
Top FET R <sub>ON</sub>	R <sub>DS(ON)1</sub>			125		mΩ
Bottom FET R <sub>ON</sub>	R <sub>DS(ON)2</sub>			75		mΩ
EN Input Voltage High	V <sub>EN,H</sub>		1.2			V
EN Input Voltage Low	V <sub>EN,L</sub>				0.4	V
PG Threshold for Under Voltage Detection	V <sub>PG,UVP</sub>			90		%
PG Low Delay Time for Under Voltage Detection	t <sub>UVP,DLY</sub>			15		μs
PG Threshold for Over Voltage Detection	V <sub>PG,OV</sub>			120		%
PG Low Delay Time for Over Voltage Detection	t <sub>OV,DLY</sub>			15		μs
Min ON Time	t <sub>ON,MIN</sub>			50		ns
Maximum Duty Cycle	D <sub>MAX</sub>		100			%
Turn On Delay Time	t <sub>ON,DLY</sub>	from EN high to LX start switching		0.25		ms
Soft-start Time	t <sub>SS</sub>	V <sub>OUT</sub> from 0% to 100%		0.75		ms
Switching Frequency	f <sub>SW</sub>	I <sub>OUT</sub> =1A, CCM		1.5		MHz
Top FET Current Limit	I <sub>LMT, TOP</sub>		3			A
Output Under Voltage Protection Threshold	V <sub>UVP</sub>			50		% V <sub>REF</sub>
Output UVP Delay	t <sub>UVP,DLY</sub>			10		μs
UVP Hiccup ON Time	t <sub>UVP,ON</sub>			1.45		ms
UVP Hiccup OFF Time	t <sub>UVP,OFF</sub>			1.45		ms
Thermal Shutdown Temperature	T <sub>SD</sub>			160		°C
Thermal Shutdown Hysteresis	T <sub>HYS</sub>			20		°C

**Note 1:** Stresses beyond the “Absolute Maximum Ratings” may cause permanent damage to the device. These are stress ratings only. Functional operation of the device at these or any other conditions beyond those indicated in the operational sections of the specification is not implied. Exposure to absolute maximum rating conditions for extended periods may affect device reliability.

**Note2:**  $\theta_{JA}$  of SY8892ARC is measured in the natural convection at T<sub>A</sub> = 25 °C on 20Z two-layer Silergy evaluation board. Pin 4 is the case position for SY8892ARC  $\theta_{JC}$  measurement.

**Note 3:** The device is not guaranteed to function outside its operating conditions.

## Typical Performance Characteristics

( $T_A = 25^\circ\text{C}$ ,  $V_{IN} = 5\text{V}$ ,  $V_{OUT} = 1.8\text{V}$ ,  $L = 1.0\mu\text{H}$ ,  $C_{OUT} = 22\mu\text{F}$ , unless otherwise noted)

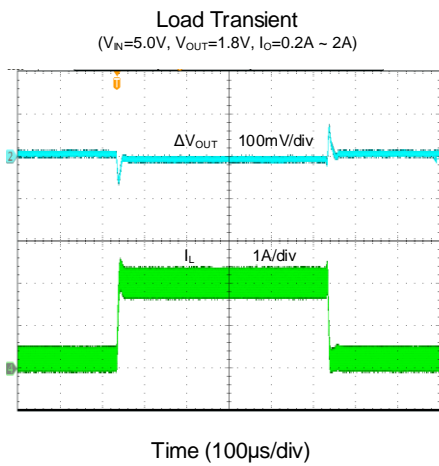
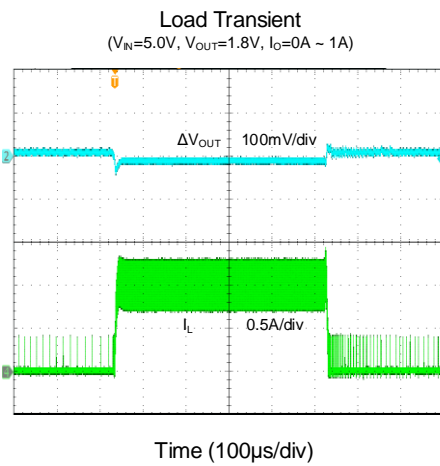
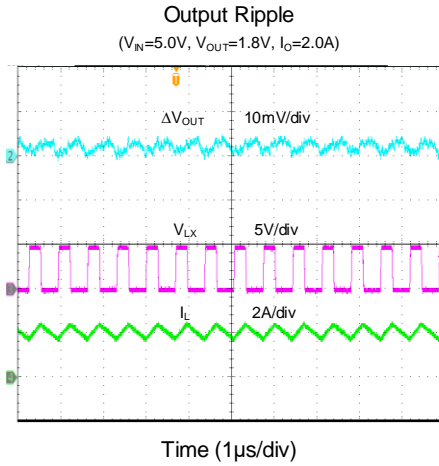
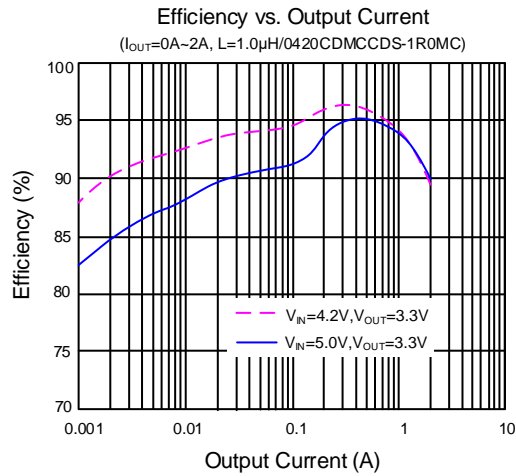
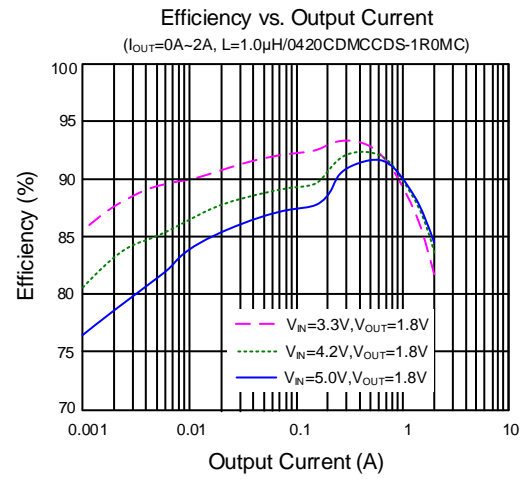
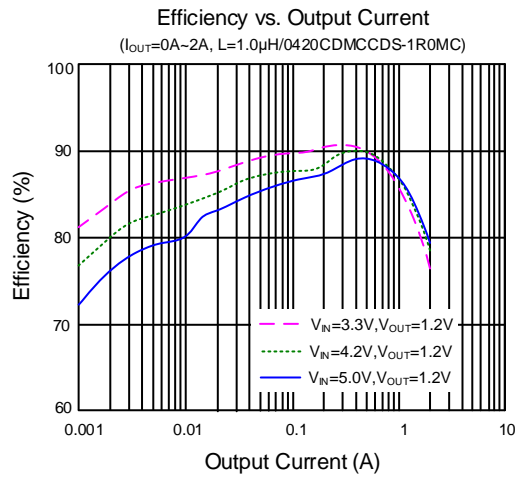

**Startup from Enable**  
 ( $V_{IN}=5.0V$ ,  $V_{OUT}=1.8V$ ,  $R_{LOAD}=0.9\Omega$ )

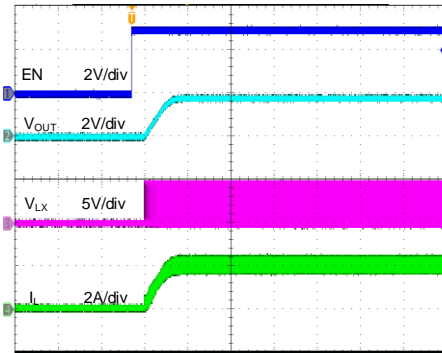

Time (800µs/div)

**Shutdown from Enable**  
 ( $V_{IN}=5.0V$ ,  $V_{OUT}=1.8V$ ,  $R_{LOAD}=0.9\Omega$ )

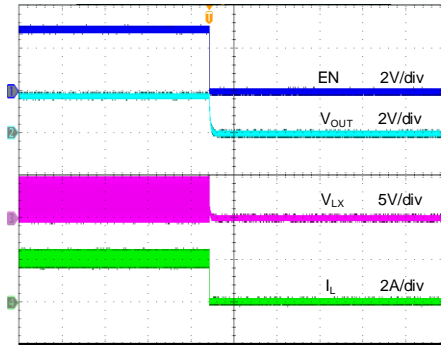

Time (800µs/div)

**Short Circuit Protection**  
 ( $V_{IN}=5.0V$ ,  $V_{OUT}=1.8V$ ,  $I_O=0A \sim$  Short)

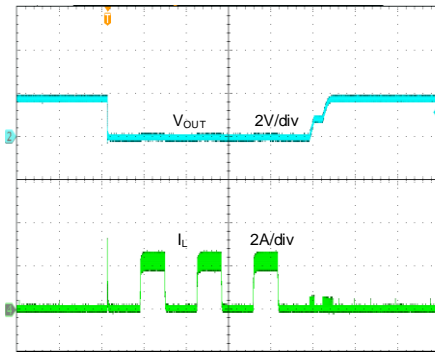

Time (2ms/div)

**Short Circuit Protection**  
 ( $V_{IN}=5.0V$ ,  $V_{OUT}=1.8V$ ,  $I_O=2A \sim$  Short)

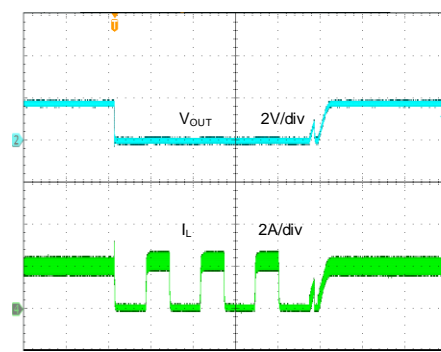

Time (2ms/div)

## Operation

The SY8892 is a high efficiency 1.5MHz synchronous step down DC/DC regulator, which is capable of delivering up to 2A output currents. It can operate over a wide input voltage range from 2.5V to 5.5V and integrates main switch and synchronous switch with very low  $R_{DS(ON)}$  to minimize the conduction loss.

The SY8892 is in a space saving, low profile SOT563 package.

## Applications Information

Because of the high integration in the SY8892, the application circuit based on this regulator is rather simple. Only the input capacitor  $C_{IN}$ , the output capacitor  $C_{OUT}$ , the output inductor  $L$  and the feedback resistors ( $R_H$  and  $R_L$ ) need to be selected for the targeted application specifications.

### Feedback Resistor Dividers $R_H$ and $R_L$

Choose  $R_H$  and  $R_L$  to program the proper output voltage. A value of between  $1k\Omega$  and  $1M\Omega$  is recommended for both resistors. If  $R_L = 120k\Omega$  is chosen, then  $R_H$  can be calculated to be:

$$R_H = \frac{(V_{OUT} - 0.6V) \times R_L}{0.6V}$$

### Input Capacitor $C_{IN}$

A typical X5R or better grade ceramic capacitor with 10V rating and greater than  $10\mu F$  capacitance is recommended. To minimize the potential noise problem, this ceramic capacitor should be placed really close to the IN and GND pins. Care should be taken to minimize the loop area formed by  $C_{IN}$  and the IN/GND pins.

### Output Capacitor $C_{OUT}$

The output capacitor is selected to handle the output ripple noise requirements. Both steady state ripple and transient requirements must be taken into consideration when selecting this capacitor. For the best performance, it is recommended to use an X5R or better grade ceramic capacitor with 6.3V rating and greater than  $22\mu F$  capacitance.

### Output Inductor $L$

There are several considerations in choosing this inductor.

- 1) Choose the inductance to provide the desired ripple current. It is suggested to choose the ripple

current to be about 40% of the maximum output current. The inductance is calculated as:

$$L = \frac{V_{OUT}(1 - V_{OUT}/V_{IN,MAX})}{f_{SW} \times I_{OUT,MAX} \times 40\%}$$

Where  $f_{SW}$  is the switching frequency and  $I_{OUT,MAX}$  is the maximum load current.

- 2) The saturation current rating of the inductor must be selected to be greater than the peak inductor current under full load conditions.

$$I_{SAT, MIN} > I_{OUT, MAX} + \frac{V_{OUT}(1 - V_{OUT}/V_{IN,MAX})}{2 \times f_{SW} \times L}$$

- 3) The DCR of the inductor and the core loss at the switching frequency must be low enough to achieve the desired efficiency requirement. It is desirable to choose an inductor with  $DCR < 50m\Omega$  to achieve a good overall efficiency.

### Load Transient Considerations

The SY8892 regulator integrates the compensation components to achieve good stability and fast transient responses. In some applications, adding a  $22pF$  ceramic capacitor in parallel with  $R_H$  may further speed up the load transient responses and is thus recommended for applications with large load transient step requirements.

### Layout Design

The layout design of the SY8892 is relatively simple. For the best efficiency and to minimize noise problems, the following components should be placed close to the IC:  $C_{IN}$ ,  $L$ ,  $R_H$  and  $R_L$ .

- 1) It is desirable to maximize the PCB copper area connecting to the GND pin to achieve the best thermal and noise performance. If the board space allowed, a ground plane is highly desirable. Reasonable paths are suggested to be placed underneath the ground pad to enhance the soldering quality and thermal performance.
- 2)  $C_{IN}$  must be close to pins IN and GND. The loop area formed by  $C_{IN}$  and GND must be minimized.
- 3) The PCB copper area associated with the LX pin must be minimized to avoid the potential noise problem.
- 4) The components  $R_H$  and  $R_L$  and the trace connecting to the FB pin must NOT be adjacent to the LX net on the PCB layout to avoid the noise problem.

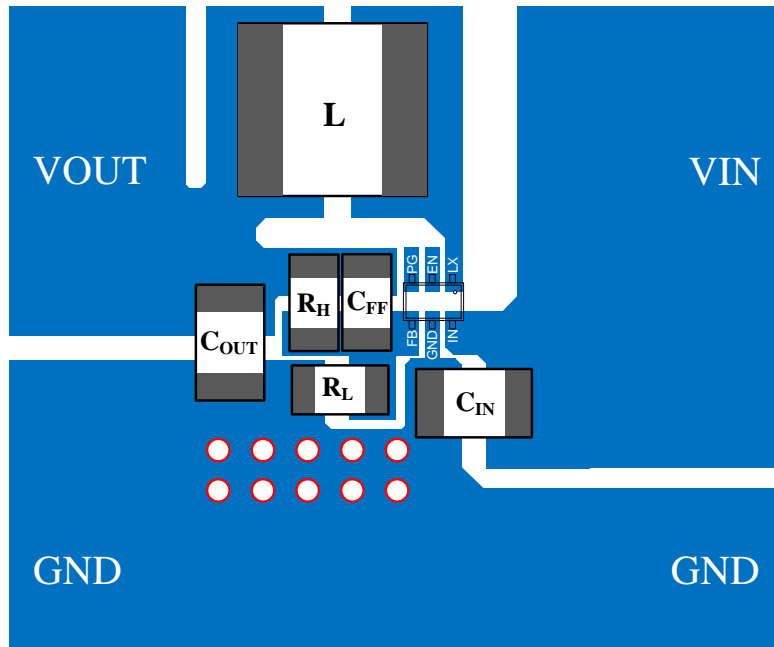
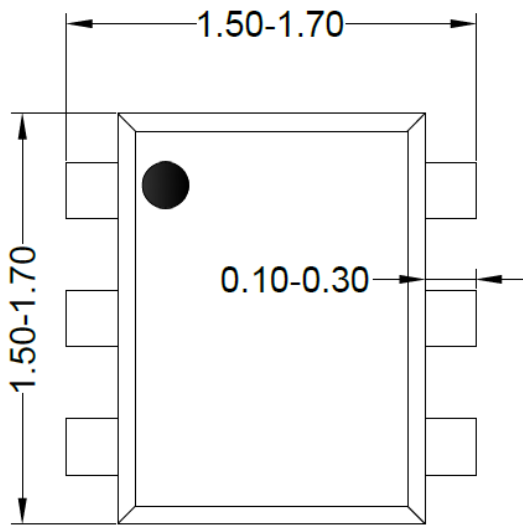

Figure4. PCB Layout Suggestion



**SOT563 Package Outline Drawing**



**Top view**

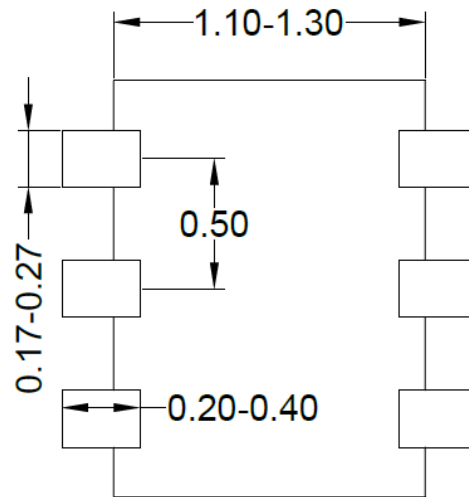

**Bottom view**

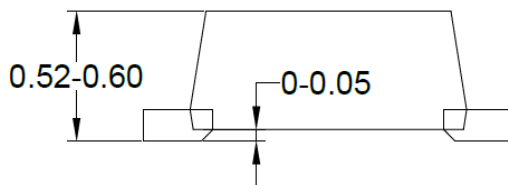

**Side View**

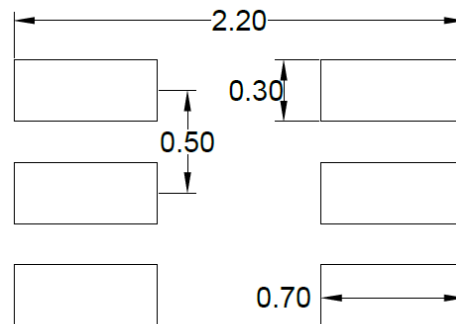

**Recommended PCB layout  
(Reference only)**

**Notes: All dimension in millimeter and exclude mold flash & metal burr.**

## Taping & Reel Specification

### 1. Taping Orientation

**SOT563**

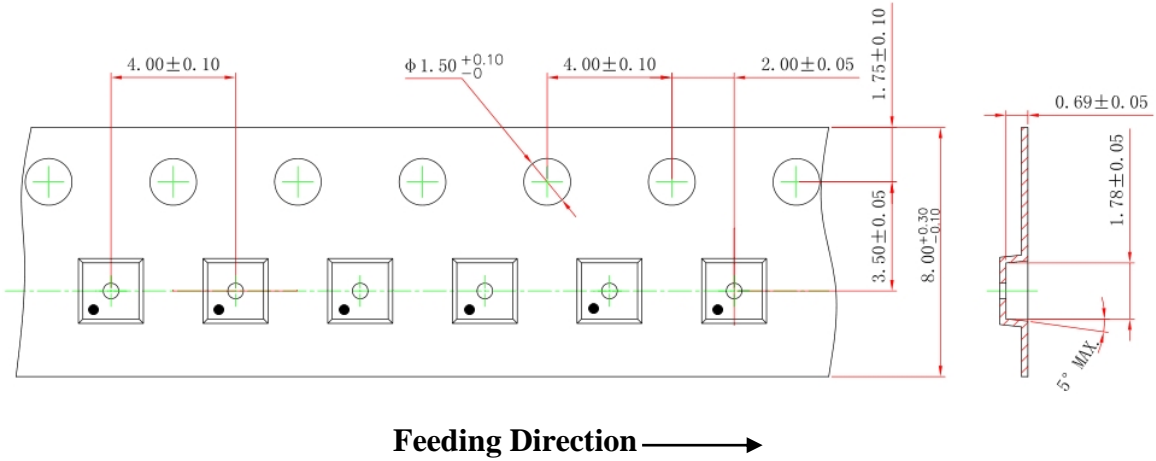

### 2. Carrier Tape & Reel specification for packages

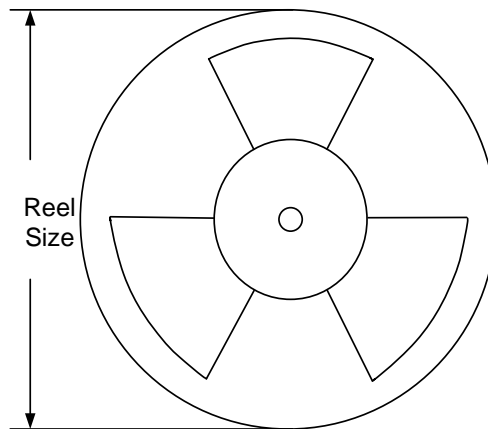

Package types	Tape width (mm)	Pocket pitch(mm)	Reel size (Inch)	Trailer * length(mm)	Leader * length (mm)	Qty per reel (pcs)
SOT563	8	4	7"	280	160	5000

### 3. Others: NA

## Revision History

The revision history provided is for informational purpose only and is believed to be accurate, however, not warranted. Please make sure that you have the latest revision.

<b>Date</b>	<b>Revision</b>	<b>Change</b>
Jun. 11, 2020	Revision 0.9	Initial Release

**IMPORTANT NOTICE**

- 1. Right to make changes.** Silergy and its subsidiaries (hereafter Silergy) reserve the right to change any information published in this document, including but not limited to circuitry, specification and/or product design, manufacturing or descriptions, at any time and without notice. This document supersedes and replaces all information supplied prior to the publication hereof. Buyers should obtain the latest relevant information before placing orders and should verify that such information is current and complete. All semiconductor products are sold subject to Silergy's standard terms and conditions of sale.
- 2. Applications.** Application examples that are described herein for any of these products are for illustrative purposes only. Silergy makes no representation or warranty that such applications will be suitable for the specified use without further testing or modification. Buyers are responsible for the design and operation of their applications and products using Silergy products. Silergy or its subsidiaries assume no liability for any application assistance or designs of customer products. It is customer's sole responsibility to determine whether the Silergy product is suitable and fit for the customer's applications and products planned. To minimize the risks associated with customer's products and applications, customer should provide adequate design and operating safeguards. Customer represents and agrees that it has all the necessary expertise to create and implement safeguards which anticipate dangerous consequences of failures, monitor failures and their consequences, lessen the likelihood of failures that might cause harm and take appropriate remedial actions. Silergy assumes no liability related to any default, damage, costs or problem in the customer's applications or products, or the application or use by customer's third-party buyers. Customer will fully indemnify Silergy, its subsidiaries, and their representatives against any damages arising out of the use of any Silergy components in safety-critical applications. It is also buyers' sole responsibility to warrant and guarantee that any intellectual property rights of a third party are not infringed upon when integrating Silergy products into any application. Silergy assumes no responsibility for any said applications or for any use of any circuitry other than circuitry entirely embodied in a Silergy product.
- 3. Limited warranty and liability.** Information furnished by Silergy in this document is believed to be accurate and reliable. However, Silergy makes no representation or warranty, expressed or implied, as to the accuracy or completeness of such information and shall have no liability for the consequences of use of such information. In no event shall Silergy be liable for any indirect, incidental, punitive, special or consequential damages, including but not limited to lost profits, lost savings, business interruption, costs related to the removal or replacement of any products or rework charges, whether or not such damages are based on tort or negligence, warranty, breach of contract or any other legal theory. Notwithstanding any damages that customer might incur for any reason whatsoever, Silergy' aggregate and cumulative liability towards customer for the products described herein shall be limited in accordance with the Standard Terms and Conditions of Sale of Silergy.
- 4. Suitability for use.** Customer acknowledges and agrees that it is solely responsible for compliance with all legal, regulatory and safety-related requirements concerning its products, and any use of Silergy components in its applications, notwithstanding any applications-related information or support that may be provided by Silergy. Silergy products are not designed, authorized or warranted to be suitable for use in life support, life-critical or safety-critical systems or equipment, nor in applications where failure or malfunction of an Silergy product can reasonably be expected to result in personal injury, death or severe property or environmental damage. Silergy assumes no liability for inclusion and/or use of Silergy products in such equipment or applications and therefore such inclusion and/or use is at the customer's own risk.
- 5. Terms and conditions of commercial sale.** Silergy products are sold subject to the standard terms and conditions of commercial sale, as published at <http://www.silergy.com/stdterms>, unless otherwise agreed in a valid written individual agreement specifically agreed to in writing by an authorized officer of Silergy. In case an individual agreement is concluded only the terms and conditions of the respective agreement shall apply. Silergy hereby expressly objects to and denies the application of any customer's general terms and conditions with regard to the purchase of Silergy products by the customer.
- 6. No offer to sell or license.** Nothing in this document may be interpreted or construed as an offer to sell products that is open for acceptance or the grant, conveyance or implication of any license under any copyrights, patents or other industrial or intellectual property rights. Silergy makes no representation or warranty that any license, either express or implied, is granted under any patent right, copyright, mask work right, or other intellectual property right. Information published by Silergy regarding third-party products or services does not constitute a license to use such products or services or a warranty or endorsement thereof. Use of such information may require a license from a third party under the patents or other intellectual property of the third party, or a license from Silergy under the patents or other intellectual property of Silergy.

For more information, please visit: [www.silergy.com](http://www.silergy.com)

© 2020 Silergy Corp.

**All Rights Reserved.**