

General Description

SY8859L is a high efficient 1.0MHz synchronous step down DC/DC regulator capable of delivering up to 3A output current. The SY8859L can operate over a wide input voltage range from 2.7V to 5.5V and integrates main switch and synchronous switch with very low $R_{DS(ON)}$ to minimize the conduction loss.

SY8859L integrates reliable latch off function when output over voltage, output short or thermal shutdown happens.

The low output voltage ripple, the small external inductor and the capacitor sizes are achieved with 1.0MHz switching frequency.

Features

- Low $R_{DS(ON)}$ for Internal Switches (Top/Bottom) 85m Ω /50m Ω
- 2.7~5.5V Input Voltage Range
- 55 μ A Low Quiescent Current
- Ultra Fast Load Transient Speed
- High Switching Frequency 1.0MHz Minimizes the External Components
- Internal Soft-start Limits the Inrush Current
- Reliable Latch off Function When:
 - Output Short
 - Thermal Shutdown
 - Output Voltage > 120% of Regulated Voltage
- Output Auto Discharge Function
- RoHS Compliant and Halogen Free
- Compact Package: QFN1.5 \times 1.5-7

Ordering Information

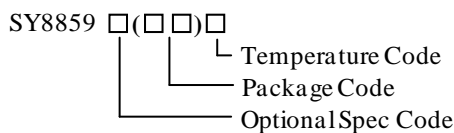

Ordering Number	Package type	Note
SY8859LQWC	QFN1.5 \times 1.5-7	--

Applications

- Smart Phone
- LCD TV
- Set Top Box
- Mini-Notebook PC
- Access Point Router

Typical Applications

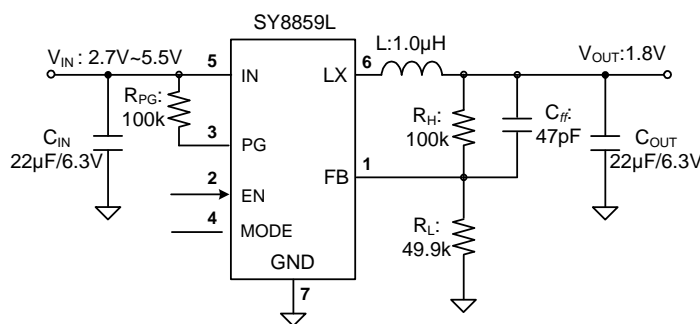

Figure1. Schematic Diagram

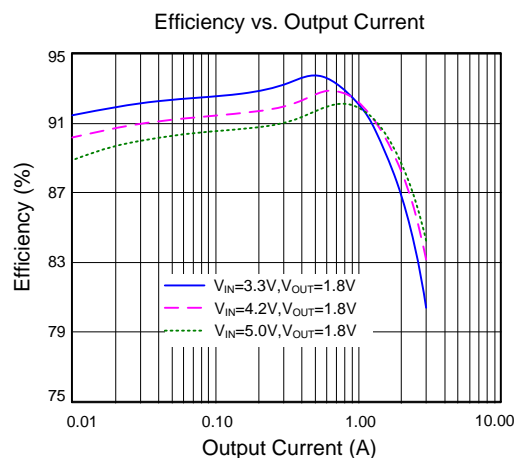
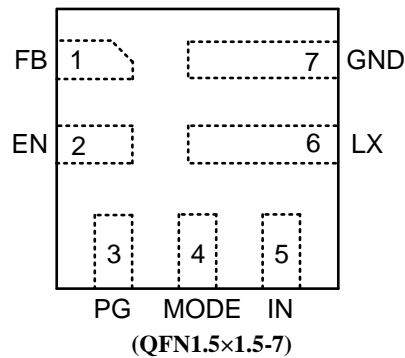

Figure2. Efficiency vs. Output Current

Pinout (Top View)



Top Mark: Vdxyz (device code: Vd, x=*year code*, y=*week code*, z=*lot number code*)

Pin Name	Pin Number	Pin Description
FB	1	Feedback pin. Connect this pin to the center point of the output resistor divider (as shown in Figure 1) to program the output voltage: $V_{OUT}=0.6V \times (1+R_H/R_L)$
EN	2	Enable control. Pull high to turn on. Do not leave it floating.
PG	3	Power good indicator (Open drain output). Low if the output < 90% of regulation voltage or the output >120% of regulation voltage. High otherwise. Connect a pull-up resistor to the input pin.
MODE	4	Mode control pin. Do not leave it floating. MODE=high, selected Force CCM mode operation during light load. MODE=low, selected PFM mode operation during light load.
IN	5	Input pin. Decouple this pin to GND pin with at least a 22μF ceramic capacitor.
LX	6	Inductor pin. Connect this pin to the switching node of the inductor.
GND	7	Ground pin.

Block Diagram

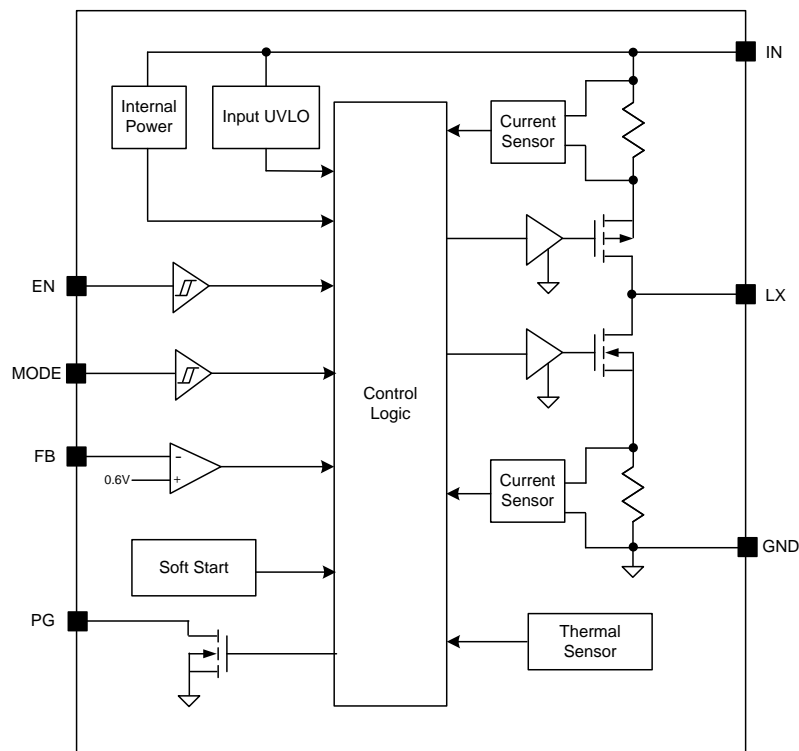

Figure3. Block Diagram

Absolute Maximum Ratings (Note 1)

Supply Input Voltage	-----	6.0V
EN, PG, MODE, FB Voltage	-----	$V_{IN} + 0.6V$
LX Voltage	-----	$-0.3V^{(*1)}$ to $6V^{(*2)}$
Power Dissipation, P_D @ $T_A = 25^\circ C$, QFN1.5x1.5-7	-----	1.5W
Package Thermal Resistance (Note 2)		
θ_{JA}	-----	66°C/W
θ_{JC}	-----	5°C/W
Junction Temperature Range	-----	-40°C to 150°C
Lead Temperature (Soldering, 10 sec)	-----	260°C
Storage Temperature Range	-----	-65°C to 150°C
(*1) LX Voltage Tested Down to -3V<40ns		
(*2) LX Voltage Tested Up to +7V<40ns		

Recommended Operating Conditions (Note 3)

Supply Input Voltage	-----	2.7V to 5.5V
Junction Temperature Range	-----	-40°C to 125°C
Ambient Temperature Range	-----	-40°C to 85°C



Electrical Characteristics

($V_{IN} = 5.0V$, $V_{OUT} = 1.8V$, $L = 1.0\mu H$, $C_{OUT} = 22\mu F$, $T_A = 25^\circ C$, unless otherwise specified)

Parameter	Symbol	Test Conditions	Min	Typ	Max	Unit
Input Voltage Range	V_{IN}		2.7		5.5	V
Input UVLO Threshold	V_{UVLO}				2.7	V
Input UVLO Hysteresis	V_{HYS}			0.18		V
Quiescent Current	I_Q	$V_{FB} = V_{REF} \times 105\%$		55		μA
Shutdown Current	I_{SHDN}	$EN = 0V$		0.1	1	μA
Feedback Reference Voltage	V_{REF}		594	600	606	mV
Output Discharge Resistance	R_{DIS}			75		Ω
Top FET R_{ON}	$R_{DS(ON)1}$			85		m Ω
Bottom FET R_{ON}	$R_{DS(ON)2}$			50		m Ω
EN Input Voltage High	$V_{EN,H}$		1.1			V
EN Input Voltage Low	$V_{EN,L}$				0.4	V
MODE Input Voltage High	$V_{MODE,H}$		1.1			V
MODE Input Voltage Low	$V_{MODE,L}$				0.4	V
PG Threshold for Under Voltage Detection	$V_{PG,UVP}$			90		% V_{REF}
PG Low Delay Time for Under Voltage Detection	$t_{UVP,DLY}$			15		μs
PG Threshold for Over Voltage Detection	$V_{PG,OVP}$			120		% V_{REF}
PG Low Delay Time for Over Voltage Detection	$t_{OVP,DLY}$			10		μs
Min ON Time	$t_{ON,MIN}$			80		ns
Maximum Duty Cycle	D_{MAX}		60			%
Turn On Delay	$t_{ON,DLY}$	from EN high to LX start switching		90		μs
Soft-start Time	t_{SS}			0.35		ms
Switching Frequency	F_{SW}	CCM		1.0		MHz
Top FET Current Limit	$I_{LMT, TOP}$		4			A
Bottom FET Current Limit	$I_{LMT, BOT}$		3			A
Output Under Voltage Protection Threshold	V_{UVP}			40		% V_{REF}
Output UVP Delay	$t_{UVP,DLY}$			15		μs
Thermal Shutdown Temperature	T_{SD}			150		$^\circ C$
Thermal Shutdown Hysteresis	T_{HYS}			15		$^\circ C$
Output Over Voltage Threshold	V_{OVP}			120		%
Output Ovp Delay Time	$V_{OVP,DLY}$			10		μs

Note 1: Stresses beyond the “Absolute Maximum Ratings” may cause permanent damage to the device. These are stress ratings only. Functional operation of the device at these or any other conditions beyond those indicated in the operational sections of the specification is not implied. Exposure to absolute maximum rating conditions for extended periods may affect device reliability.

Note 2: θ_{JA} of SY8859LQWC is measured in the natural convection at $T_A = 25^\circ C$ on a 20Z two-layer Silergy evaluation board. Pin6 is the case position for SY8859LQWC θ_{JC} measurement.

Note 3: The device is not guaranteed to function outside its operating conditions.

Typical Performance Characteristics

Efficiency vs. Output Current

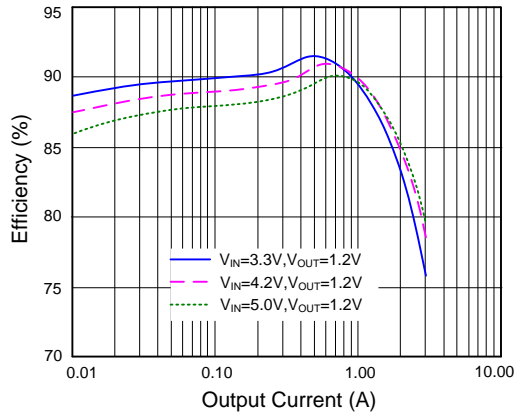

Efficiency vs. Output Current

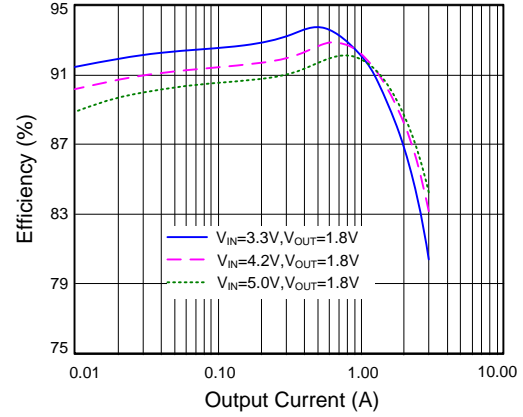

Load Transient

($V_{IN}=5.0V, V_{OUT}=1.8V, I_O=0 \sim 1.5A$)

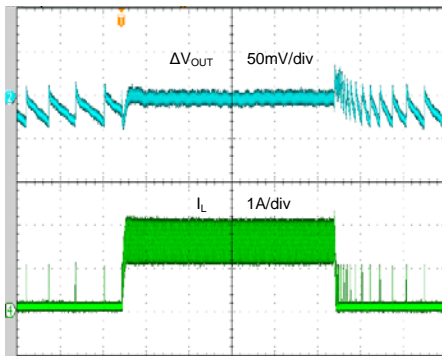

Time (100 μ s/div)

Load Transient

($V_{IN}=5.0V, V_{OUT}=1.8V, I_O=0.3 \sim 3.0A$)

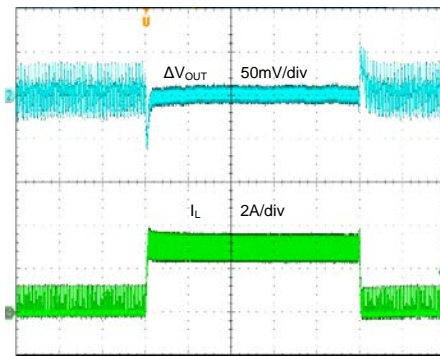

Time (100 μ s/div)

Startup from Enable

($V_{IN}=5.0V, V_{OUT}=1.8V, I_O=3.0A$)

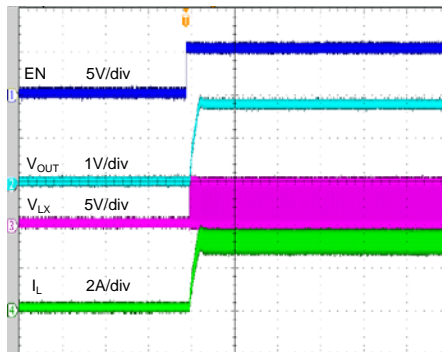

Time (800 μ s/div)

Shutdown from Enable

($V_{IN}=5.0V, V_{OUT}=1.8V, I_O=3.0A$)

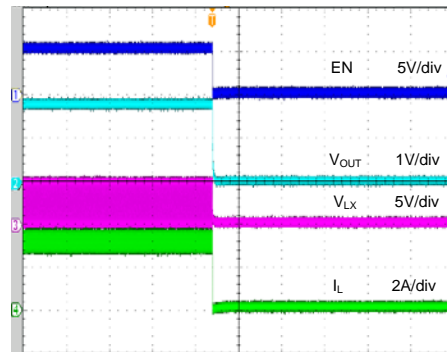

Time (800 μ s/div)

Short Circuit Protection
 ($V_{IN}=5.0V$, $V_{OUT}=1.8V$, $I_O=0A$ ~ short)

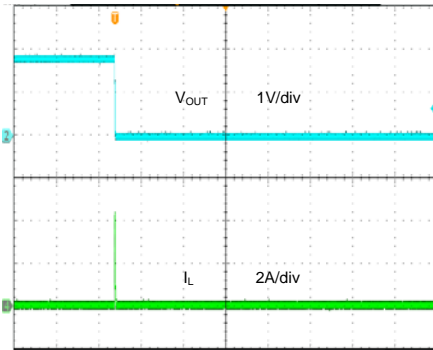

Time (2ms/div)

Short Circuit Protection
 ($V_{IN}=5.0V$, $V_{OUT}=1.8V$, $I_O=3.0A$ ~ short)

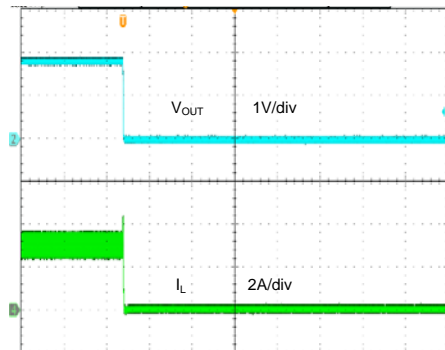

Time (2ms/div)

Output Ripple
 ($V_{IN}=5.0V$, $V_{OUT}=1.8V$, $I_O=3.0A$)

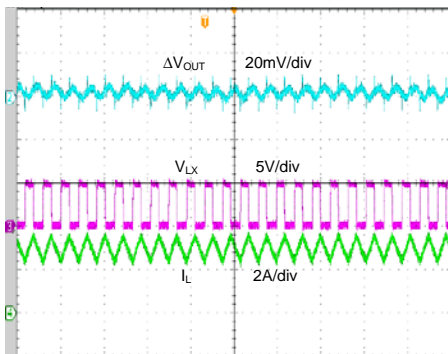

Time (2 μ s/div)

Operation

SY8859L is a high efficient 1.0MHz synchronous step down DC/DC regulator capable of delivering up to 3A output current. The SY8859L can operate over a wide input voltage range from 2.7V to 5.5V and integrates main switch and synchronous switch with very low $R_{DS(ON)}$ to minimize the conduction loss.

SY8859L integrates reliable latch off function when output over voltage, output short or thermal shutdown happens.

The low output voltage ripple, the small external inductor and the capacitor sizes are achieved with 1.0MHz switching frequency.

Short Circuit Protection

After the soft-start is over, if the output voltage falls below 40% of the regulation level, the IC will turn off both power switches, then enters short circuit protection. It will remain in this state until the IN or EN voltage is recycled.

Over Voltage Protection

If the output voltage exceeds 120% of the regulation level for more than 10 μ s, the IC will turn off both power switches and turn on the discharge switch, then enters over voltage protection. It will remain in this state until the IN or EN voltage is recycled.

Thermal Shutdown Protection

If the junction temperature of SY8859L is greater than the thermal shutdown temperature (T_{SD}), the IC will turn off both power switches, and then enters thermal shutdown protection. It will remain in this state until the IN or EN voltage is recycled.

Applications Information

Because of the high integration of SY8859L, the application circuit based on this regulator IC is rather simple. Only input capacitor C_{IN} , output capacitor C_{OUT} , output inductor L and feedback resistors (R_H and R_L) need to be selected for the target application specifications.

Feedback Resistor Dividers R_H and R_L :

Choose R_H and R_L to program the proper output voltage. To minimize the power consumption under light load, it is desirable to choose large resistance

values for both R_H and R_L . A value of between 100k Ω and 1M Ω is highly recommended for both resistors. If $R_L = 120k\Omega$ is chosen, then R_H can be calculated to be:

$$R_H = \frac{(V_{OUT} - 0.6V) \cdot R_L}{0.6V}$$

Input Capacitor C_{IN} :

A typical X5R or better grade ceramic capacitor with 6.3V rating and greater than 22 μ F capacitance is recommended. To minimize the potential noise problem, we should place this ceramic capacitor really close to the IN and GND pins. Care should be taken to minimize the loop area formed by C_{IN} , and IN/GND pins.

Output Inductor L:

There are several considerations in choosing this inductor.

- 1) Choose the inductance to provide the desired ripple current. It is suggested to choose the ripple current about 40% of the maximum output current. The inductance is calculated as:

$$L = \frac{V_{OUT}(1 - V_{OUT}/V_{IN,MAX})}{F_{SW} \times I_{OUT,MAX} \times 40\%}$$

Where F_{SW} is the switching frequency and $I_{OUT,MAX}$ is the maximum load current.

- 2) The saturation current rating of the inductor must be selected to be greater than the peak inductor current under full load conditions.

$$I_{SAT,MIN} > I_{OUT,MAX} + \frac{V_{OUT}(1 - V_{OUT}/V_{IN,MAX})}{2 \times F_{SW} \times L}$$

- 3) The DCR of the inductor and the core loss at the switching frequency must be low enough to achieve the desired efficiency requirement. It is desirable to choose an inductor with $DCR < 25m\Omega$ to achieve good overall efficiency.

Inductor vs. Output Capacitor:

The ripple base control strategy needs very small C_{OUT} to confirm stability. Too large the inductor and C_{OUT} will lead to instability. The recommend inductance and the output capacitor are shown as below.

Table1. Inductance vs. Output Capacitor Selection Table

L	C _{OUT}					
	10μF	22μF	22μF×2	22μF×4	22μF×6	22μF×8
1.0μH	×	√	√	√	√	√
1.5μH	×	√	√	√	×	×
2.2μH	×	√	√	×	×	×

Layout Design:

The layout design of SY8859L regulator is relatively simple. For the best efficiency and to minimum noise problems, we should place the following components close to the IC: C_{IN}, L, R_H and R_L.

1) It is desirable to maximize the PCB copper area adjacent to GND pin to achieve the best thermal performance and noise performance. If the board space allowed, a ground plane is highly desirable. Reasonable vias are suggested to be placed

underneath the ground pad to enhance the soldering quality and thermal performance.

2) C_{IN} must be close to pins IN and GND. The loop area formed by C_{IN} and GND must be minimized.

3) The PCB copper area adjacent to LX pin must be minimized to avoid the potential noise problem.

4) The components R_H, R_L, and the trace connected to the FB pin must NOT be adjacent to the LX pin net on the PCB layout to avoid the noise problem.

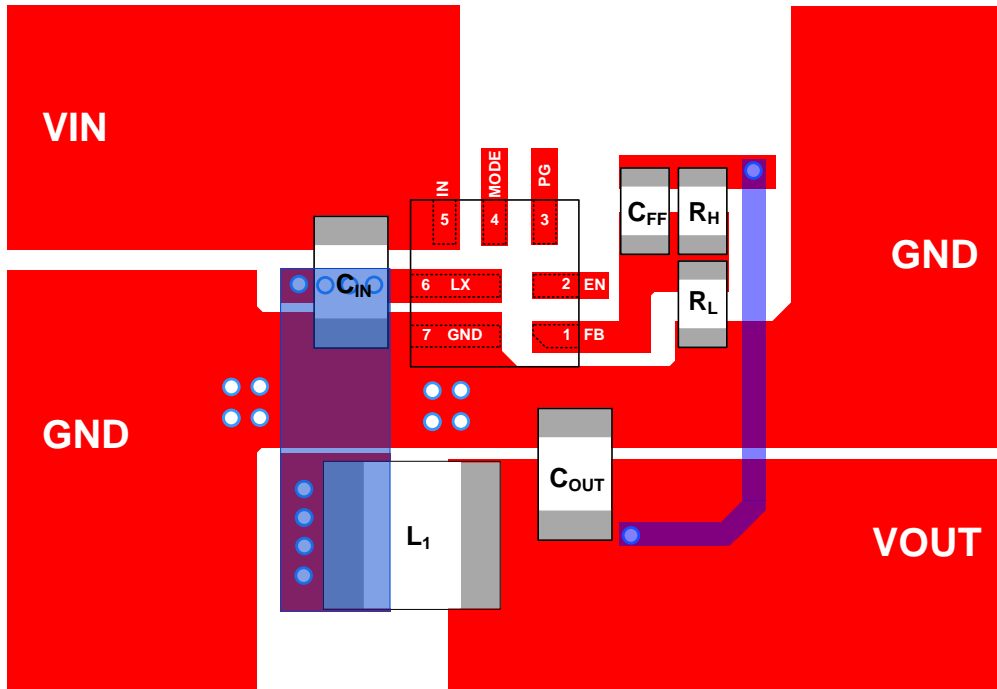
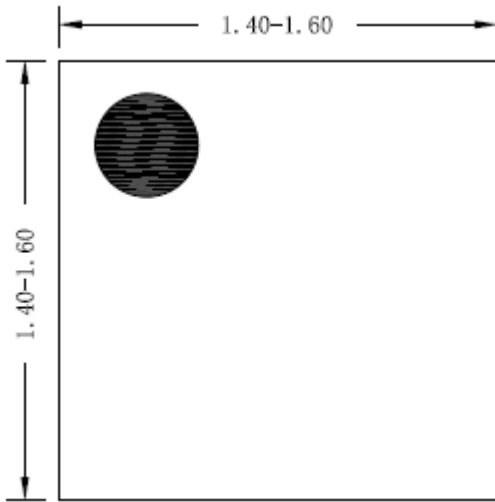
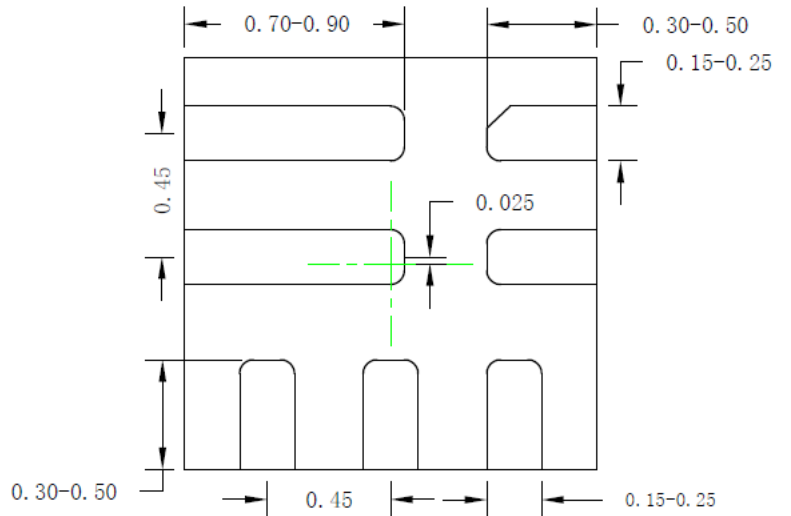

Figure4. PCB Layout Suggestion

QFN1.5×1.5-7 Package Outline Drawing



Top View



Bottom View

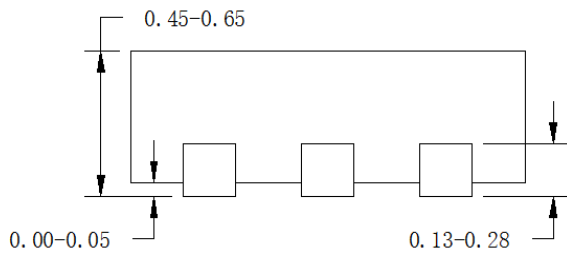

Side View

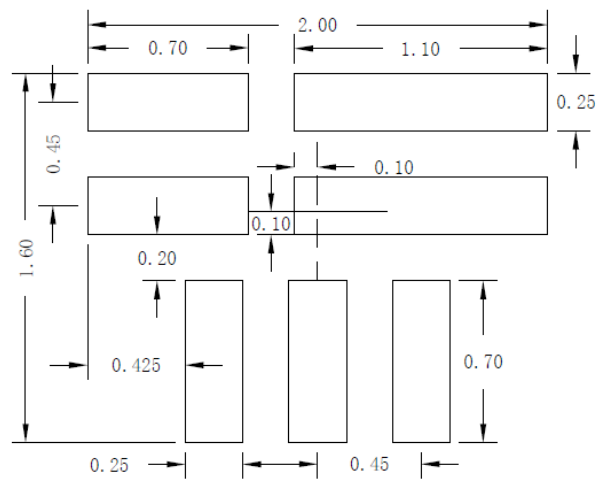

Recommended PCB Layout

Notes: All dimension in millimeter and exclude mold flash & metal burr.

Taping & Reel Specification

1. QFN1.5×1.5 taping orientation

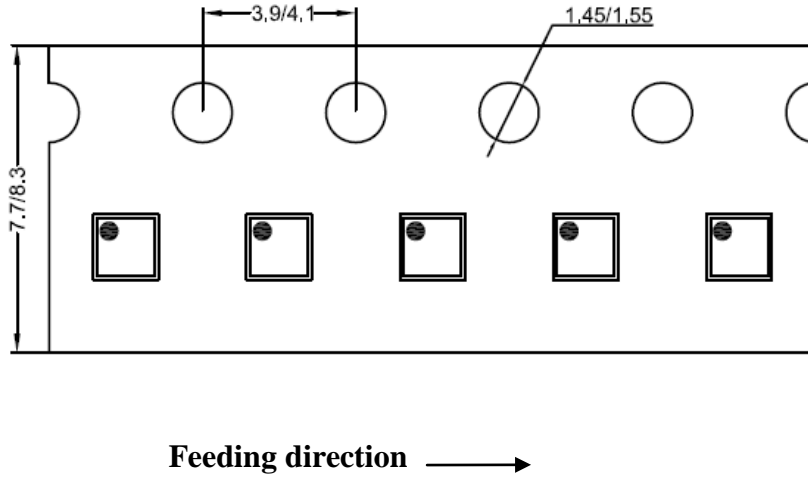

2. Carrier Tape & Reel specification for packages

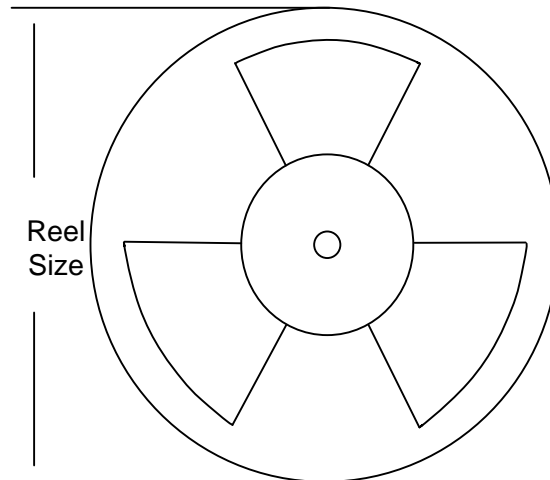

Package types	Tape width (mm)	Pocket pitch(mm)	Reel size (Inch)	Trailer length(mm)	Leader length (mm)	Qty per reel
QFN1.5×1.5	8	4	7"	400	160	3000

3. Others: NA



Revision History

The revision history provided is for informational purpose only and is believed to be accurate, however, not warranted. Please make sure that you have the latest revision.

Date	Revision	Change
Sep.09, 2022	Revision 0.9B	Update the dimensions in the Bottom View of the Package outline drawing. (page9)
Jan. 22, 2021	Revision 0.9A	Update the package outline drawing (page9)
Aug.07, 2017	Revision 0.9	Initial Release



IMPORTANT NOTICE

- 1. Right to make changes.** Silergy and its subsidiaries (hereafter Silergy) reserve the right to change any information published in this document, including but not limited to circuitry, specification and/or product design, manufacturing or descriptions, at any time and without notice. This document supersedes and replaces all information supplied prior to the publication hereof. Buyers should obtain the latest relevant information before placing orders and should verify that such information is current and complete. All semiconductor products are sold subject to Silergy's standard terms and conditions of sale.
- 2. Applications.** Application examples that are described herein for any of these products are for illustrative purposes only. Silergy makes no representation or warranty that such applications will be suitable for the specified use without further testing or modification. Buyers are responsible for the design and operation of their applications and products using Silergy products. Silergy or its subsidiaries assume no liability for any application assistance or designs of customer products. It is customer's sole responsibility to determine whether the Silergy product is suitable and fit for the customer's applications and products planned. To minimize the risks associated with customer's products and applications, customer should provide adequate design and operating safeguards. Customer represents and agrees that it has all the necessary expertise to create and implement safeguards which anticipate dangerous consequences of failures, monitor failures and their consequences, lessen the likelihood of failures that might cause harm and take appropriate remedial actions. Silergy assumes no liability related to any default, damage, costs or problem in the customer's applications or products, or the application or use by customer's third-party buyers. Customer will fully indemnify Silergy, its subsidiaries, and their representatives against any damages arising out of the use of any Silergy components in safety-critical applications. It is also buyers' sole responsibility to warrant and guarantee that any intellectual property rights of a third party are not infringed upon when integrating Silergy products into any application. Silergy assumes no responsibility for any said applications or for any use of any circuitry other than circuitry entirely embodied in a Silergy product.
- 3. Limited warranty and liability.** Information furnished by Silergy in this document is believed to be accurate and reliable. However, Silergy makes no representation or warranty, expressed or implied, as to the accuracy or completeness of such information and shall have no liability for the consequences of use of such information. In no event shall Silergy be liable for any indirect, incidental, punitive, special or consequential damages, including but not limited to lost profits, lost savings, business interruption, costs related to the removal or replacement of any products or rework charges, whether or not such damages are based on tort or negligence, warranty, breach of contract or any other legal theory. Notwithstanding any damages that customer might incur for any reason whatsoever, Silergy' aggregate and cumulative liability towards customer for the products described herein shall be limited in accordance with the Standard Terms and Conditions of Sale of Silergy.
- 4. Suitability for use.** Customer acknowledges and agrees that it is solely responsible for compliance with all legal, regulatory and safety-related requirements concerning its products, and any use of Silergy components in its applications, notwithstanding any applications-related information or support that may be provided by Silergy. Silergy products are not designed, authorized or warranted to be suitable for use in life support, life-critical or safety-critical systems or equipment, nor in applications where failure or malfunction of an Silergy product can reasonably be expected to result in personal injury, death or severe property or environmental damage. Silergy assumes no liability for inclusion and/or use of Silergy products in such equipment or applications and therefore such inclusion and/or use is at the customer's own risk.
- 5. Terms and conditions of commercial sale.** Silergy products are sold subject to the standard terms and conditions of commercial sale, as published at <http://www.silergy.com/stdterms>, unless otherwise agreed in a valid written individual agreement specifically agreed to in writing by an authorized officer of Silergy. In case an individual agreement is concluded only the terms and conditions of the respective agreement shall apply. Silergy hereby expressly objects to and denies the application of any customer's general terms and conditions with regard to the purchase of Silergy products by the customer.
- 6. No offer to sell or license.** Nothing in this document may be interpreted or construed as an offer to sell products that is open for acceptance or the grant, conveyance or implication of any license under any copyrights, patents or other industrial or intellectual property rights. Silergy makes no representation or warranty that any license, either express or implied, is granted under any patent right, copyright, mask work right, or other intellectual property right. Information published by Silergy regarding third-party products or services does not constitute a license to use such products or services or a warranty or endorsement thereof. Use of such information may require a license from a third party under the patents or other intellectual property of the third party, or a license from Silergy under the patents or other intellectual property of Silergy.

For more information, please visit: www.silergy.com

©2022 Silergy Corp.

All Rights Reserved.